

OLYMPUS[®]

DIGITAL VOICE
RECORDER

DS-2300

**ONLINE
INSTRUCTIONS**

Thank you for purchasing an Olympus
Digital Voice Recorder.

Please read these instructions for information
about using the product correctly and safely.
Keep the instructions handy for future reference.

To ensure successful recordings, we
recommend that you test the record function
and volume before use.

EN

Table of Contents

Table of Contents	2
Safe and Proper Usage	4
General Precautions	4

1 Getting Started

Main Features	6
xD-Picture Card	8
Identification of Parts	9
Inserting Batteries	11
Turning ON the Recorder	12
Power Save Mode	12
Setting Time/Date (TIME&DATE)	13
Inserting and Ejecting a Card	16

2 Basic Operations

Recording	18
Microphone Sensitivity (MIC SENSE)	22
Recording Modes (REC MODE)	23
Using the Variable Control Voice Actuator (VCVA)	24
Recording Monitor	26
Playing	27
Erasing	29

3 Other Functions

Locking Files (LOCK)	31
Index Marks	32
LCD Display Information	33
Formatting the Card (FORMAT)	35
Hold	37
LCD Contrast Adjustment (CONTRAST)	38

Backlight (BACKLIGHT)	39
System Sounds (BEEP)	40
Menu Setting Method	41

4 Preparation Before Using DSS Player

Using DSS Player Software	42
Operating Environment	43
Installing Software	44
Uninstalling Software	47
Using Online Help	49
Connection to Your PC	50
Running DSS Player	52
Window Names	54

5 Managing Files on Your PC

Download Voice Files from the Recorder	55
Play a Voice File	57
Upload Voice Files to the Recorder	58
Direct Recording/Editing on PC	60
Send Voice Files with E-mail	61
Changing User ID	61
Changing a Folder Name	62
Editing File Comments	62
USB Microphone/USB Speaker	63
Upgrade Function	65
Using Voice Recognition Software	67
Joining Files	75
Splitting Files	77
Menu Setting of this Recorder	79

6 Other Practical Use Methods

Using the Recorder as a Reader/Writer 80

7 Other Information

Alarm Message List 81

Troubleshooting 82

Accessories (optional) 83

Specifications 84

Technical Assistance and Support 85

1

2

3

4

5

6

7

Safe and Proper Usage

Before using your new recorder, read this manual carefully to ensure that you know how to operate it safely and correctly. Keep this manual in an easily accessible location for future reference.

- The warning symbols indicate important safety related information. To protect yourself and others from personal injury or damage to property, it is essential that you always read the warnings and information provided.

Convention Used In this Manual

- The word “card” is used to refer to the xD-Picture Card.
- The word “DSS Player” is used to refer to the DSS Player version 6 in Windows and Apple Macintosh environment.
- The Notes at the bottom of a page are used for additional information, exceptions, or related events.
- Words in uppercase form such as PLAY or REC are used to describe a function or button on the recorder.

General Precautions

- **Do not leave the recorder in hot, humid locations such as inside a closed automobile under direct sunlight or on the beach in the summer.**
- **Do not store the recorder in places exposed to excessive moisture or dust.**
- **Do not use organic solvents such as alcohol and lacquer thinner to clean the unit.**
- **Do not place the recorder on top of or near electric appliances such as TVs or refrigerators.**
- **Avoid recording or playing back near cellular phones or other wireless equipment, as they may cause interference and noise. If you experience noise, move to another place, or move the recorder further away from such equipment.**
- **Avoid sand or dirt. These can cause irreparable damage.**
- **Avoid strong vibrations or shocks.**
- **Do not disassemble, repair or modify the unit yourself.**

- **Do not operate the unit while operating a vehicle (such as a bicycle, motorcycle, or go-cart).**
- **Keep the unit out of the reach of children.**

<Warning regarding data loss>

Recorded content in memory may be destroyed or erased by operating mistakes, unit malfunction, or during repair work.

It is recommended to back up and save important content to other media such as a computer hard disk.

Batteries

⚠ Warning

- **Batteries should never be exposed to flame, heated, short-circuited or disassembled.**
- **Do not attempt to recharge alkaline, lithium or any other non-rechargeable batteries.**
- **Never use any battery with a torn or cracked outer cover.**
- **Keep batteries out of the reach of children.**
- **If you notice anything unusual when using this product such as abnormal noise, heat, smoke, or a burning odor:**
 - ① **remove the batteries immediately while being careful not to burn yourself, and;**
 - ② **call your dealer or local Olympus representative for service.**

1 Main Features

This product is equipped with the following features.

- Connect the USB connection cable to enable high speed data transfer to a computer. (☞ P.50)
- Recording and storing voice in DSS format.
- Two recording modes, SP (Standard Playback) mode or LP (Long Playback) mode (☞ P.23).
- It has a large backlight full-dot display (LCD display screen). (☞ P.39)
 - The screen displays information about recorded voice files and easily understood operational messages.
- The five folders can hold 199 files each, for the maximum of 995 recordings. (☞ P.18)
- It has a built-in Variable Control Voice Actuator (VCVA) function. (☞ P.24)
- You can insert or delete index marks. (☞ P.32)
 - If you insert index marks during recording or playback, you will later be able to quickly find the recording you want to hear.
- Comes with DSS Player software. (☞ P.42)
 - If you transfer voice files recorded with the recorder to a PC, you can easily play back, organize, and edit the files. (☞ P.55)
 - If you connect the recorder to a computer, you can use it as a USB microphone or USB speaker. (☞ P.63)
- The “DSS Player” can be upgraded to a “DSS Player Plus”, which is equipped with an enhanced functionality (Option). (☞ P.65)
 - If a commercial voice recognition software is utilized, the recorded voice file can be converted to characters automatically.* (☞ P.67)
 - In addition to the “DSS Player” functions, joining and splitting of the files and configuring the menu settings of this recorder, etc. can be performed.

Plus

The “DSS Player” can be upgraded to “DSS Player Plus”, which is equipped with enhanced functionality (paid option). (☞ P.65)

- *: In a quiet environment, it is necessary to set this recorder to SP mode, and that the person whose voice is registered in the speech recognition software speak with the constant tone of voice when recording.

The voice file recorded under the following conditions is not suitable for character conversion, since the software may have difficulty in recognizing the voice.

- Meetings, discussions where voices of more than one person can be recorded
- Conferences, lectures where the surrounding noise can be recorded

IBM, PC/AT, and ViaVoice are the trademarks or registered trademarks of International Business Machines Corporation.

Microsoft, Windows and Windows Media are registered trademarks of Microsoft Corporation.

Apple, Macintosh, iMac, Mac, and PowerMac are trademarks or registered trademarks of Apple Computer, Inc.

Intel and Pentium are registered trademarks of Intel Corporation.

CORTOLOGIC is a registered trademark of Ruwisch & Kollegen GmbH.

Other product and brand names mentioned herein may be the trademarks or registered trademarks of their respective owners.

ScanSoft and Dragon NaturallySpeaking are the trademarks or registered trademarks of ScanSoft, Inc.



xD-Picture Card

The xD-Picture Card is a removable recording media.

Compatible Cards

The removable card can be used to store different kind of data. Since the card has larger memory capacity than a diskette, it can be used to transfer data between different PCs. The recorder supports cards with memory capacity between 16 to 512 MB.



- ① **Index area**
You can write down the card's contents.

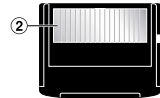

- ② **Contact area**
Comes into contact with the recorder's signal read contacts.

Memory Sizes of Cards and Approximate Recording Times*1

Memory Size	SP Mode	LP Mode
16MB	2 hr. 30 min.	5 hr. 30 min.
32MB	5 hr. 10 min.	11 hr. 05 min.
64MB	10 hr. 25 min.	22 hr. 20 min.
128MB	20 hr. 55 min.	44 hr. 45 min.
256MB	42 hr. 00 min.	89 hr. 40 min.
512MB	84 hr. 05 min.	179 hr. 30 min.*2

*1: Available recording time for one continuous file.
Available recording time may be shorter if many short recordings are made.

*2: Total recording time of two files. The maximum recording time per file is 99 hours.

Notes

- When initializing (formatting) a card, confirm that no necessary data is stored on the card beforehand. Initialization completely erases the existing data on the card.
- Cards used in a recorder must be formatted in the same recorder first unless formatted with a CAMEEDIA series Olympus digital camera. Card may not perform as expected when formatted by a different device.
- The card has a service life. When reaching the end of its life, writing or erasing data on the card will be disabled. In this case, replace the card.
- If you use a PC card adapter compatible with the card to save or delete some data on the card, the maximum recording time on the card may be decreased. To recover the original recording time, initialize/format the card in the recorder.
- Olympus will not be held liable for any data corruption or loss due to misuse of the media card.

Identification of Parts

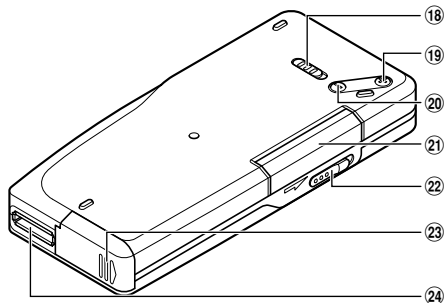
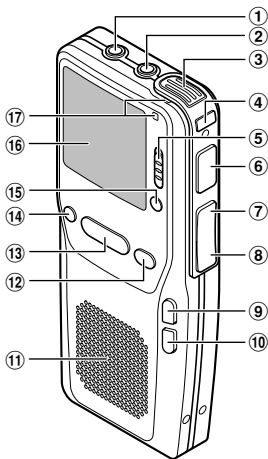

- ① EAR (Earphone) jack
- ② MIC (Microphone) jack
- ③ Built-in microphone
- ④ NEW button
- ⑤ HOLD switch
- ⑥ REC (Record) button
- ⑦ REW (Rewind) button
- ⑧ FF (Fast Forward) button
- ⑨ INDEX button
- ⑩ FOLDER/MENU button
- ⑪ Built-in speaker
- ⑫ STOP button

- ⑬ PLAY button
- ⑭ ERASE button
- ⑮ DISPLAY button
- ⑯ Display (LCD panel)
- ⑰ Record/Play indicator lamp
- ⑱ POWER (ON/OFF) switch
- ⑲ VOLUME (+) button
- ⑳ VOLUME (-) button
- ㉑ Card cover
- ㉒ Card cover lock
- ㉓ Battery cover
- ㉔ PC (USB) terminal

1 Display (LCD Panel)

Identification of Parts

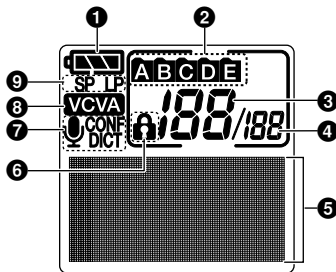

- ❶ Battery indicator
- ❷ Folder
- ❸ Current file number
- ❹ Total number of recorded files in the folder
- ❺ Character Information display
- ❻ Erase lock indicator
- ❼ Microphone sensitivity display
- ❽ VCVA (Variable Control Voice Actuator) indicator
- ❾ Record mode indicator

Inserting Batteries

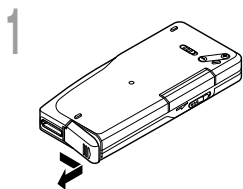

1 Lightly press down on the arrow and slide the battery cover open.

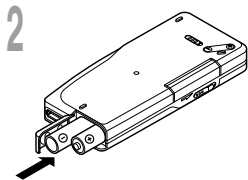

2 Insert two AAA alkaline batteries, observing the correct polarity.

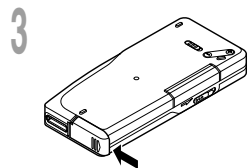

3 Close the battery cover completely.

Replacing batteries

The battery indicator on the display changes as the batteries lose power.

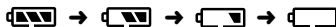

When  appears on the display, replace the batteries as soon as possible.

When the batteries are too weak, the recorder shuts down and “BATTERY LOW” appears on the display.

An optional Ni-MH Rechargeable Battery from Olympus can be used for the recorder (see P.83).

Notes

- Be sure to turn OFF the recorder before replacing the batteries. Removing the batteries while the recorder is in use may corrupt the card. If you are recording into a file and the batteries run out, you will lose your currently recorded file since the file header will not be written. It is crucial to replace the batteries when one hash mark is shown in the battery icon.
- Be sure to replace both batteries at the same time.
- Never mix old and new batteries, or batteries of different types and/or brands.
- If it takes longer than 1 minute to replace dead batteries, you may have to reset the time when you load fresh batteries (see P.13).
- Remove the batteries if you are not going to use the recorder for an extended period of time.

Turning ON the Recorder

1

Turning ON the Recorder/ Power Save Mode

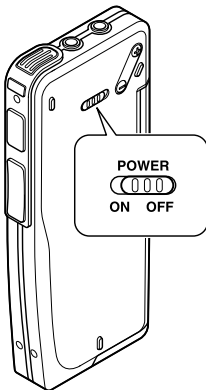

With the battery in the recorder and the card inserted properly, the recorder is ready to work.

While the power switch on the back of the recorder is in the OFF position, none of the buttons or switch on the recorder will be active. Slide the power switch to the ON position to activate the recorder.

Power Save Mode

When the recorder is ON but not in use for 10 minutes, it will switch to power save mode automatically. To reactivate the recorder again, press any of the buttons on the recorder.

Setting Time/Date (TIME&DATE)

Setting the correct time and date on the recorder is very important since every file recorded on the recorder will have the date and time information as part of the file header. This will simplify the file management aspects later on.

The hour indicator will flash automatically when you load batteries before using the recorder for the first time, or after the recorder hasn't been used for a long time. Proceed from step 1.

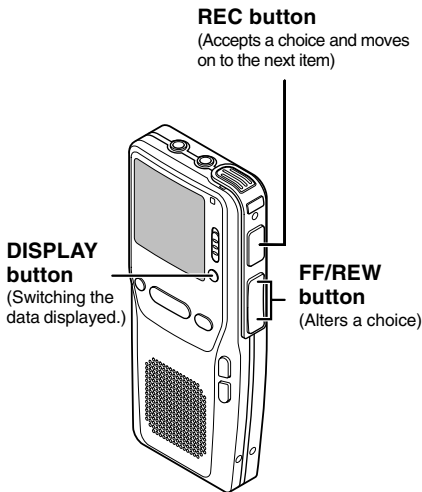

1 Set the hour.

- 1 Press the **FF** button or **REW** button to set the hour.
 - 2 Press the **REC** button to accept the hour.
- You can choose between 12 and 24 hour display by pressing the **DISPLAY** button while setting the hour and minute.

Example: 5:45 P.M.

5:45 PM ↔ 17:45

(Initial setting)

2 Set the minute.

- 1 Press the **FF** button or **REW** button to set the minute.
- 2 Press the **REC** button to accept the minute.

3 Set the year.

- 1 Press the **FF** button or **REW** button to set the year.
- 2 Press the **REC** button to accept the year.

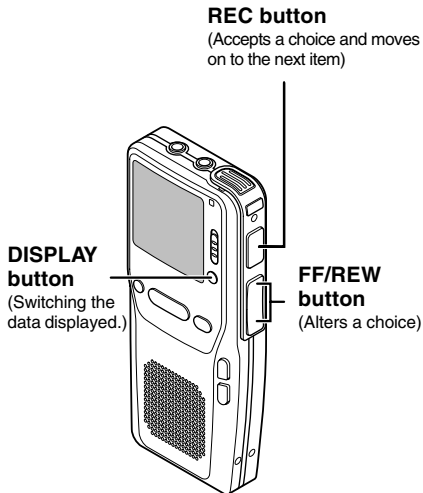

- You can choose the order of the year, month, day by pressing the DISPLAY button while setting them.

Example: March 14, 2005

3M 14D 2005Y
(Initial setting)
↓
14D 3M 2005Y
↓
2005Y 3M 14D

4 Set the month.

- ① Press the **FF** button or **REW** button to set the month.
- ② Press the **REC** button to accept the month.

5 Set the date.

- ① Press the **FF** button or **REW** button to set the date.
- ② Press the **REC** button to accept the date.

Notes

- If you press the STOP button during the setup operation, the recorder will save the items that were set to that point.
- You can set the time and date from your PC using DSS Player software (P.42).

Changing the Time/Date

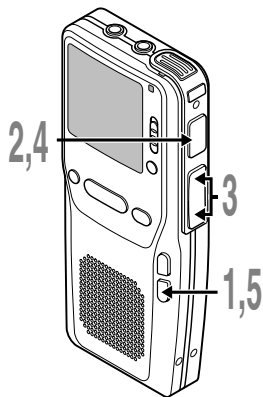

- 1 Press and hold the **FOLDER/MENU** button for 1 second or longer.

The menu appears (☞ P.41).

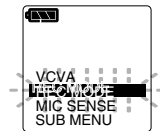

- 2 Press the **FF** or **REW** button to choose “SUB MENU”, and press the **REC** button.

The sub menu appears (☞ P.41).

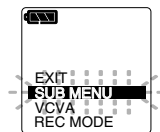

- 3 Press the **FF** or **REW** button until “TIME&DATE” flashes on the display.

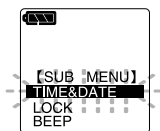

- 4 Press the **REC** button.
Time/Date screen appears. The hour indicator flashes, indicating the start of the Time/Date setup process.
Follow the same steps starting at step 1 in “Setting Time/Date” (☞ P.13).

- 5 Press the **FOLDER/MENU** button to close the menu.

Inserting and Ejecting a Card

1

Inserting and Ejecting a Card

Inserting a Card

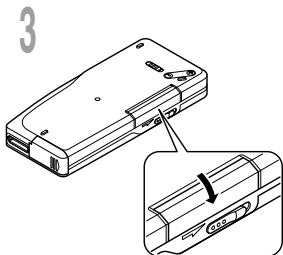
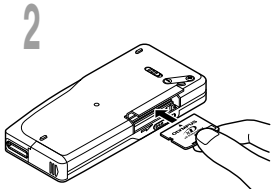
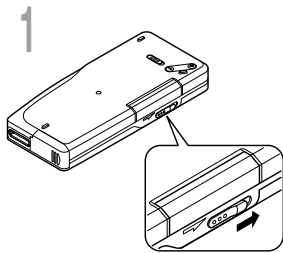

1 Slide the card cover lock in the direction indicated by the arrow.

The card cover is unlocked and the message “CARD COVER IS OPEN” appears on the display. When this message appears, the power is switched off automatically.

2 Face the card the correct way and insert it into the card slot as shown in the diagram.

- Insert the card keeping it straight.
- The card stops with a click when it is inserted all the way.
- Inserting the card the wrong way or at an angle could damage the contact area or cause the card to jam.
- If the card is not inserted all the way, data may not be written to the card.

3 Close the card cover securely.

Card inserted fully into the slot

The message “PLEASE WAIT” on the display flashes for seconds.

Card not inserted fully into the slot

When the card cover is closed, the message “INSERT CARD” on the display flashes for a few seconds. Pressing any button will sound beeps* and flash the message “INSERT CARD” again.

* When the system sounds are enabled.

Notes

- If an unformatted card is inserted, the recorder automatically displays the menu to menu format option (P.35).
- Never use any card in the recorder unless it has been formatted on this unit or on a CAMELIA series Olympus digital camera (P.35).

Ejecting a Card

1 Make sure the recorder is STOP mode.

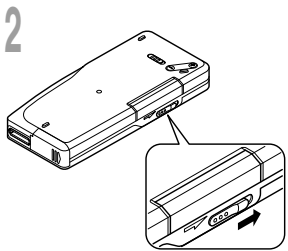

2 Slide the card cover lock in the direction indicated by the arrow.

The card cover is unlocked and the message “CARD COVER IS OPEN” appears on the display. When this message appears, the power is switched off automatically.

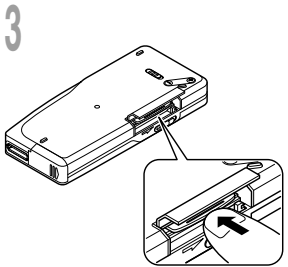

3 Push the card inward to unlock it, and let it eject partially.

The card is visibly out of the slot and can be removed safely.

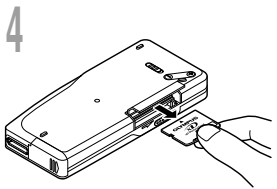

4 Hold the card straight and pull it out.

Note

Releasing your finger quickly after pushing the card inward may cause it to eject forcefully out of the slot.

Recording

2

Recording

The recorder has five folders, **A**, **B**, **C**, **D**, **E** and you can select folder by pressing the FOLDER/MENU button. These five folders can be selectively used to distinguish the kind of recording; for example, Folder **A** might be used to store private information, while Folder **B** might be dedicated to holding business information. You can use your DSS player to change a folder name (see P.62). Up to 199 messages can be recorded per folder.

All recordings made in any of the folders will be in Digital Speech Standard (DSS) format. By default, the RECORD function is configured to record at the current position (overwrite). However, that can be changed to any of the following settings:

- Append: Appends the recording to the end of the current file.
- Insert: Inserts the recording at the current position in the file.
- Overwrite: Overwrites the recording starting at the current position in the file.

New Recording

Create a new file to record in.

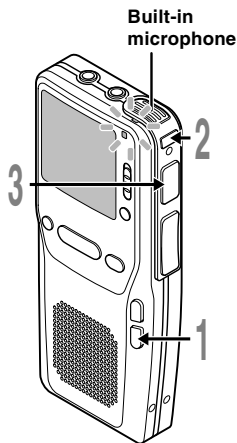

1 Press the FOLDER/MENU button to choose a folder.

The folder name is displayed for 2 seconds.

2 Press the NEW button to create a new file.

- (a) Current recording mode
- (b) New file number
- (c) Selected Author ID

3 Press the REC button to start recording.

The record/play indicator lamp glows red. Aim the microphone at the sound source.

- (d) Current recording time
- (e) Remaining recording time

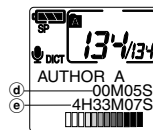
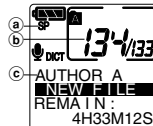

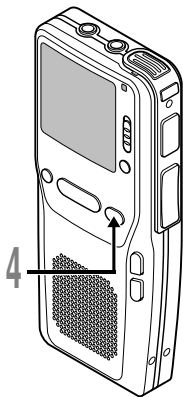

4 Press the **STOP** button to stop recording.

If you want to append additional recordings to the same file, press the REC button again.

Pause

Press the **REC** button while recording.

➡ “REC PAUSE” will flash on the display.

- The recorder stops when it has been left paused for 10 minutes or longer.

Resume Recording

Press the **REC** button again.

➡ Recording will resume at the point of interruption.

Review Recording

Press the **REW** button when recording, and release it when you want to start playback. The recorder plays up to the end of file, then stops.

You can overwrite or append additional recordings in the same file from that point.

Notes

- A beep will sound when remaining recording time reaches 60 seconds, 30 seconds, and 10 seconds while recording.
- “MEMORY FULL” or “FOLDER FULL” will be displayed when the memory or folder capacity is full. Delete any unnecessary files before recording any further (☞ P.29) or transfer voice files to your computer using DSS Player Software (☞ P.42).
- You cannot select a different recording mode (SP or LP) than that of the original file when appending recording (☞ P.23).
- While recording, pressing the **PLAY** button stops recording and plays back the current file.

Overwrite Recording

You can overwrite a previously recorded file from any point within the file. Note that the overwritten recordings will be erased.

2

Recording

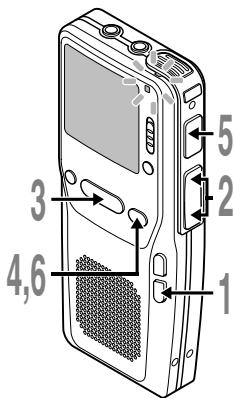

1 Press the **FOLDER/MENU** button to choose a folder.

The folder name is displayed for 2 seconds.

2 Press the **FF** or **REW** button to choose the file into which you want to overwrite.

3 Press the **PLAY** button to play the file.

- a Current playback time
- b Total recording time of the file being played

4 Press the **STOP** button where you want to start overwriting.

5 Press the **REC** button to start overwriting.

The record/play indicator lamp glows red.

6 Press the **STOP** button to stop overwriting.

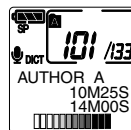
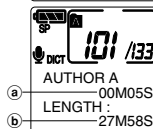
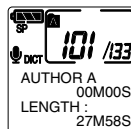

Note

You cannot select a different recording mode (SP, LP) than that of the original file before overwrite recording.

Insert Recording

Additional recording can be inserted into previously recorded file.

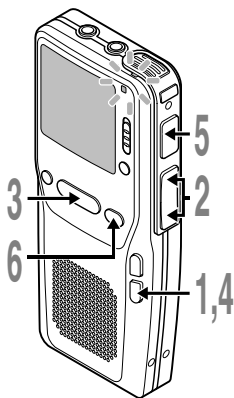

1 Press the FOLDER/MENU button to choose a folder.

The folder name is displayed for 2 seconds.

2 Press the FF or REW button to choose the file into which you want to insert additional recordings.

3 Press the PLAY button to start playback.

4 While playing the file, press the FOLDER/MENU button to insert an additional recording.

“INSERT ?” appears on the display.

5 Press the REC button to start inserting additional recording.

The record/play indicator lamp glows red. “INSERT REC” and the remaining recording time will alternate on the display.

6 Press the STOP button to stop inserting additional recording.

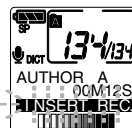
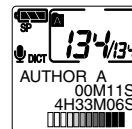
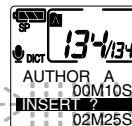
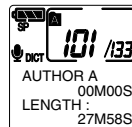

Notes

- The recording time and date of the file is updated to the time and date of the inserted recording.
- You cannot select a different recording mode (SP, LP) than that of the original file before inserting.

Microphone Sensitivity (MIC SENSE)

Microphone sensitivity is adjustable to meet recording needs.

2

Microphone Sensitivity (MIC SENSE)

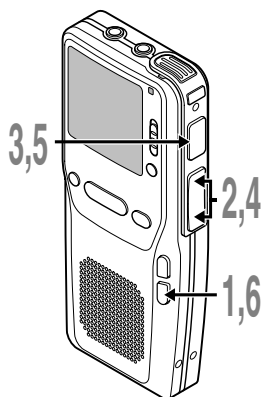

1 Press and hold the FOLDER/MENU button for 1 second or longer.

The menu appears (see P.41).

2 Press the FF or REW button to choose “MIC SENSE” flashes on the display.

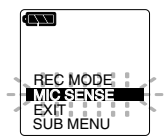

3 Press the REC button.
The microphone sensitivity setup process begins.

4 Press the FF or REW button to choose between “CONF.” and “DICT.”.

CONF.: High-sensitivity mode that records sounds in all directions.

DICT.: Low-sensitivity mode suited for dictation.



5 Press the REC button to complete the setup screen.

6 Press the FOLDER/MENU button to close the menu.

Note

If you want to record clear or noise-free dictation, select DICT mode and place the microphone 5 cm to 10 cm (2 to 4 inches) from the source.

Recording Modes (REC MODE)

The recording mode can choose between SP (standard recording) and LP (long-term recording).

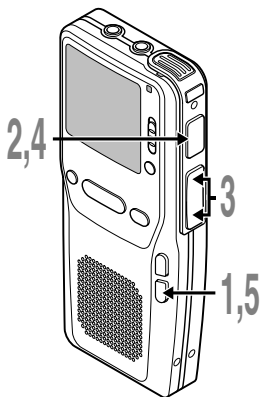

- 1 Press and hold the **FOLDER/MENU** button for 1 second or longer.

“REC MODE” will be displayed on the screen (P.41).

- 2 Press the **REC** button.
The recording mode setup process begins.

- 3 Press the **FF** or **REW** button to choose between “SP” and “LP”.

- 4 Press the **REC** button to complete the setup screen.

- 5 Press the **FOLDER/MENU** button to close the menu.

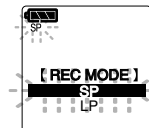
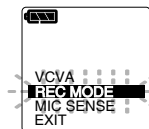

2

Recording Modes (REC MODE)

Note

Choose SP mode for recording meetings or lectures with crisp clarity.

Using the Variable Control Voice Actuator (VCVA)

When the microphone senses that sounds have reached a preset threshold volume level, the built-in Variable Control Voice Actuator (VCVA) starts recording automatically, and stops when the volume drops below the threshold level.

The VCVA feature extends recording time and conserves memory by turning off recording during silent periods. This helps make the playback, with no lulls or dead space, more efficient and convenient.

2

Using the Variable Control Voice Actuator (VCVA)

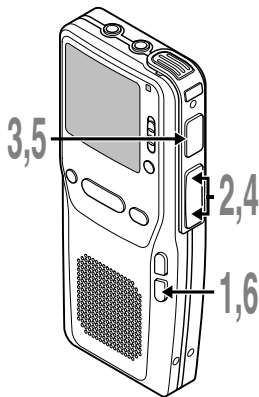

- 1 Press and hold the **FOLDER/MENU** button for 1 second or longer.

The menu appears (see P.41).

- 2 Press the **FF** or **REW** button to choose “VCVA” flashes on the display.

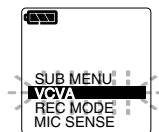

- 3 Press the **REC** button.

The VCVA setup process begins.

- 4 Press the **FF** or **REW** button to choose between “ON” and “OFF”.

ON: Will start recording in VCVA mode.
OFF: Will resume recording in normal mode.

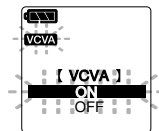

- 5 Press the **REC** button to complete the setup screen.

- 6 Press the **FOLDER/MENU** button to close the menu.

When “ON” is selected, a VCVA indication will be displayed on the screen.



7 Press the REC button to start recording.

When the sound volume is lower than the preset threshold sound level, recording automatically stops after 1 sec approximately, and “STANDBY” flashes on the display. The record/play indicator lamp glows when recording starts and flashes when recording pauses.

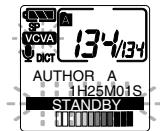

2

Using the Variable Control Voice Actuator (VCVA)

Adjust the start/stop actuation level

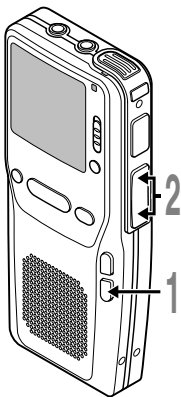

1 Press the FOLDER/MENU button during recording.

The VCVA level screen displayed.

2 Press the FF or REW button to adjust the pause sound level.

The VCVA level can be set to any of 15 different values. The higher the value, the more sensitive the recorder to sounds. At the highest value, even the faintest sound will activate recording.

The VCVA pause sound level can be adjusted according to the ambient (background) noise.

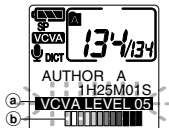

- a Level meter (varies according to the sound volume being recorded)
- b Start level (moves to the right/left according to the set level)

Notes

- The start/stop actuation level also varies depending on the selected microphone sensitivity mode (Ⓜ P.22).
- If the starting level is not adjusted within 2 seconds, the display will return to the previous.
- To ensure successful recordings, prior testing and adjustment of the start/stop actuation level is recommended.

Recording Monitor

If you start recording after inserting the earphone into the EAR jack on the recorder, you can hear the sound being recorded. The sound volume on the recording monitor can be adjusted by pressing the VOLUME (+) or VOLUME (-) button.

2

Recording Monitor

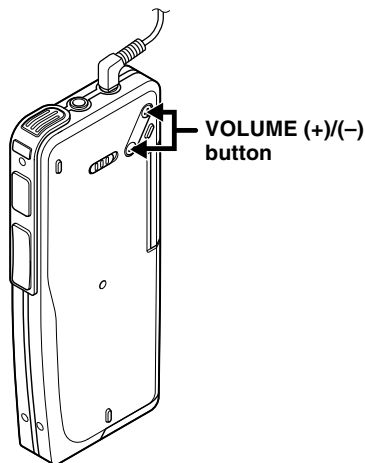

Connect the earphone to the EAR jack on the recorder.

After recording is started, you can hear the sound being recorded through the earphone.

If the earphone is connected, no sound will come from the speaker.

Notes

- Recording level cannot be controlled using the volume button.
- When using the earphones, do NOT set the volume too high. Listening at very high volume may lead to hearing loss.

Playing

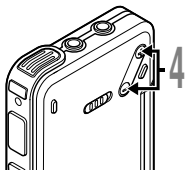
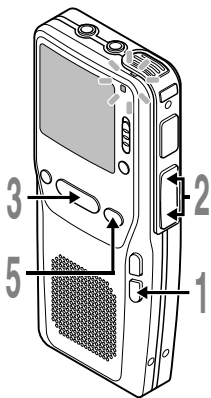

1 Press the **FOLDER/MENU** button to choose folder.

2 Press the **FF** or **REW** button to choose the file that you want to play.

3 Press the **PLAY** button to start playback.

The record/play indicator lamp glows green.

- a** Current playback time
- b** Total recording time of the file being played

4 Press the **VOLUME (+)** or **VOLUME (-)** button to select the proper sound volume.

The display shows the volume level. You can choose between 0 to 30.

5 Press the **STOP** button at any point you want to stop the playback.

Resume playback by pressing PLAY button again.

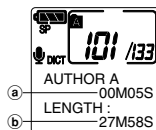
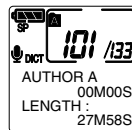

2

Playing

Playback functions

2

Playing

Playback functions	Operation	How to Cancel
Fast Forward (FF)	Press the FF button once while stopped.	Press the PLAY button. ➤ The recorder starts the operation of the set position.
Rewind (REW)	Press the REW button once while stopped.	
Cue (CUE)	Hold the FF button while stopped or playing a file.	Release the FF button.
Review (REV)	Hold the REW button while stopped or playing a file.	Release the REW button.

- If you press the FF button once while fast-forwarding or twice while stopped, the recorder will stop at the end of the file (F.SKIP).
- If you press the REW button once while rewinding or twice while stopped, the recorder will stop at the beginning of the file (B.SKIP). If the REW button is pressed within 2 seconds, the recorder skips to the beginning of the previous file.

Erasing

Erasing One File

A selected file can be erased from a folder.

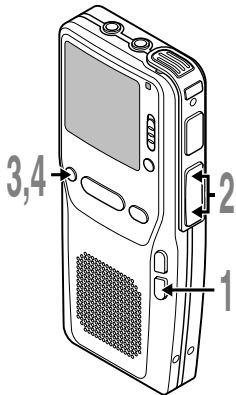

1 Press the **FOLDER/MENU** button to choose a folder.

2 Press the **FF** or **REW** button to choose the file you want to erase.

3 Press the **ERASE** button.
“FILE ERASE ?” flashes on the display for approximately 8 seconds.

4 Press the **ERASE** button once more while “FILE ERASE ?” is flashing.

The display changes to “FILE ERASE!” and erasing will start.

“ERASE DONE” is displayed when the file is erased. File numbers will be reassigned automatically.

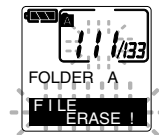
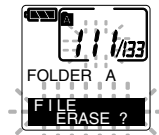

Notes

- An erased file cannot be restored.
- The file set to erase lock will not be erased (P.31).

Erase All Files in a Folder

All files in a folder can be erased simultaneously, except for locked files (P.31).

2

Erasing

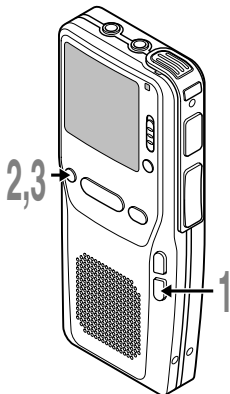

1 Press the **FOLDER/MENU** button to choose the folder you want to erase all files.

2 Press the **ERASE** button for 3 seconds or longer.
“ALL ERASE ?” flashes on the display for approximately 8 seconds.

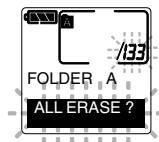

3 Press the **ERASE** button once more while “ALL ERASE ?” is flashing.
The display changes to “ALL ERASE!” and erasing will start.

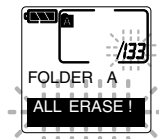

“ERASE DONE” is displayed when the files are erased. Locked files are reassigned file numbers in ascending order.



Notes

- An erased file cannot be restored.
- The file set to erase lock will not be erased (P.31).
- Completion of erasing may take 10 seconds. Never do anything during this period because data may be corrupted. Battery removal setting/removal are not permissible, whether or not the battery is set in the recorder.

Locking Files (LOCK)

Locking a file keeps important data from being accidentally erased.

Locked files are not erased when you choose to erase all files from a folder (P.29).

Locked files are never erased except when the card is formatted (P.35).

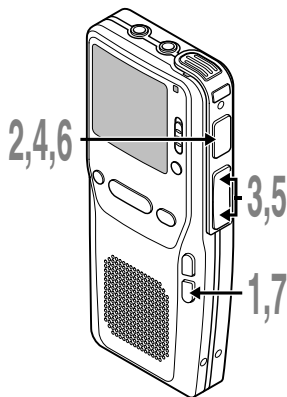

- 1 Select the file you want to **LOCK**, press and hold the **FOLDER/MENU** button for 1 second or longer.

The menu appears (P.41).

- 2 Press the **FF** or **REW** button to choose “**SUB MENU**”, and press the **REC** button.

The sub menu appears (P.41).

- 3 Press the **FF** or **REW** button until “**LOCK**” flashes on the display.

- 4 Press the **REC** button.

The file locking setup process begins.

- 5 Press the **FF** or **REW** button to choose between “**ON**” and “**OFF**”.

ON: Locks the file and prevents it from being edited or erased.

OFF: Unlocks the file and allows it to be edited or erased.

a Erase lock indicator

- 6 Press the **REC** button to complete the setup screen.

- 7 Press the **FOLDER/MENU** button to close the menu.

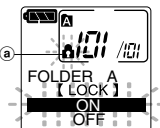
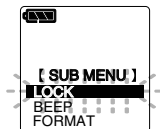
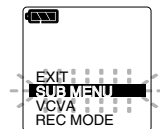

Index Marks

Index marks can be placed in a file during recording or playback to provide a quick and easy way of keeping track of important sections in the file.

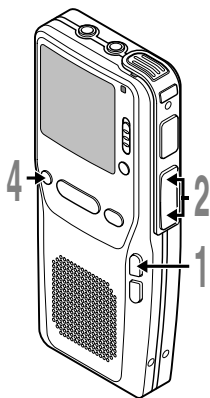

3

Index Marks

Setting an Index Mark

- 1 Press the **INDEX** button during recording or playback to set an index mark.

An index number appears on the display.



Locating an Index Mark

- 2 Hold the **FF** or **REW** button while playing a file.

The recorder stops for 1 second when it reaches the index mark.

Clearing an Index Mark

- 3 Locate the index mark you want to clear.

- 4 Press the **ERASE** button while the index number appears for approximately 2 seconds on the display.

The index mark is erased.

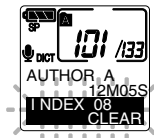

Notes

- Up to 16 index marks can be set in a file. Attempting to set more index marks will cause "INDEX FULL" to appear on the display.
- Index marks cannot be set or cleared in a locked file (Ⓜ P.31).

LCD Display Information

The LCD screen on the recorder can display 6 different format of information by pressing the DISPLAY button. This help review and confirm different recorder settings and file information.

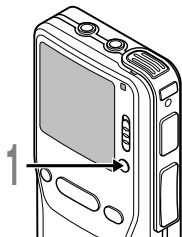

- 1 Press the **DISPLAY** button.**
The LCD display views will switch every time the DISPLAY button is pressed.

While in stop or playback mode

When pressing Display, the recorder will cycle through ① to ⑥. If there is no file, ⑤ and ⑥ will display alternately.

① **File length**

Shows how long a file is.

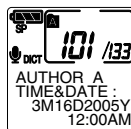

⑥ **Current time and date**

Shows the current time and date. (During playback, the "TIME & DATE" or the counter appears.)

② **Time stamp**

Shows the year, month, and date that the file was recorded.



⑤ **Memory remaining**

Shows remaining recording time.

③ **Time stamp**

Shows the time that the file was recorded.



④ **File comment***

Shows comment added to a file. (If there is no comment, "----" will appear.)

* If a comment contains many characters, it will scroll horizontally to display the complete comment.

While in record mode

① Recording level meter

Displays the sound input level graphically and the remaining time available for recording in countdown mode.

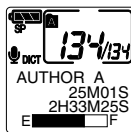

② Remaining memory bars

Displays the remaining time available for recording in bar mode and countdown mode.

While recording in VCVA mode

① VCVA recording level meter

Displays the sound input level graphically and the remaining time available for recording in countdown mode.

("STANDBY" appears if the VCVA actuation level isn't reached.)

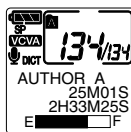

② Remaining memory bars

Displays the remaining time available for recording in bar mode and countdown mode.

While in Overwrite Record Mode

① Recording level meter

Displays the sound input level graphically, the current time and the length of the file.

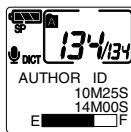

② Remaining memory bars

Displays the remaining time available for recording in bar mode, and the current time and length of the file.

While in Insert Record Mode

① Recording level meter

Displays flashing "INSERT REC", the sound input level graphically, and the current recording time.



② Remaining memory bars

Displays flashing "INSERT REC", the remaining time available for recording in bar mode, and the current recording time.

Formatting the Card (FORMAT)

Cards that have been used on non-Olympus devices, or cards that are not recognized by the recorder, must be formatted before they can be used with the recorder. The Olympus xD-Picture Card delivered with the recorder is preformatted and ready for use. To familiarize yourself with the formatting process, read the steps below.

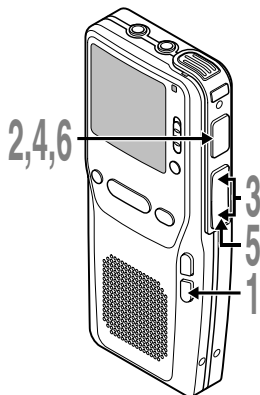

- 1 Press and hold the **FOLDER/MENU** button for 1 second or longer.

The menu appears (see P.41).

- 2 Press the **FF** or **REW** button to choose “SUB MENU”, and press the **REC** button.

The sub menu appears (see P.41).

- 3 Press the **FF** or **REW** button until “FORMAT” flashes on the display.

- 4 Press the **REC** button.

The formatting process is selected.

- 5 Press the **FF** button to choose “START”.

- 6 Press the **REC** button.
“DATA WILL BE CLEARED” appears for approximately 2 seconds.

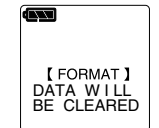
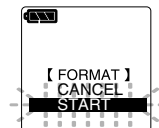
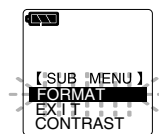
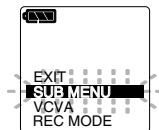

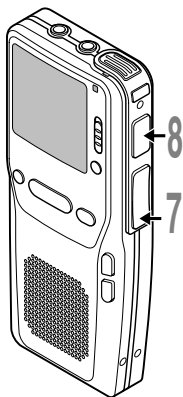

7 Press the **FF** button again to choose “**START**”.

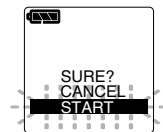

8 Press the **REC** button again. Formatting begins and an indicator flashes on the display.

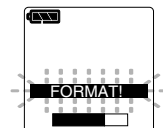

“**FORMAT DONE**” displays when formatting ends.

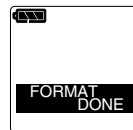

Notes

- The time required to format cards differs depending on the capacity of cards. For example, formatting may take about 1 minute for 512 MB card. Do not interrupt the formatting process by opening the card cover or the battery cover. Doing so will damage the data or card.
- When the card is formatted, all the stored data, including locked files, are erased.
- If an unformatted card is inserted, the recorder automatically displays the format option in the menu.

Hold

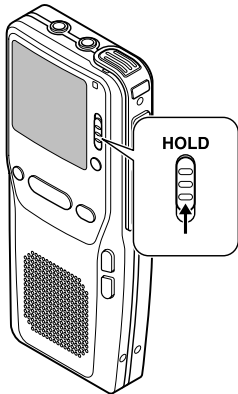

Setting the **HOLD** switch to the **HOLD** position.

If you set the recorder to HOLD status by sliding the HOLD switch in the direction of the arrow, the current conditions will be preserved, and all buttons and switches except the HOLD switch will be disabled. This feature is useful when the recorder has to be carried in a bag or pocket.

Remember to reset the HOLD switch when using the recorder.

3

Hold

Notes

- The display will flash if the switch is moved to hold in the stop status. At this time, if any button is pressed the clock display will flash for about 2 seconds, but will not operate.
- If the switch is moved to hold during playback (or recording), the playback (recording) status will stay and cannot be operated.

(When playback has ended and the recording has ended due the remaining memory being used up, it will be in the stop state.)

LCD Contrast Adjustment (CONTRAST)

If you find it difficult to read the display information due to lighting, temperature, or other conditions, you can adjust the contrast using this function to easily see the LCD display (display contrast).

Display contrast can be adjusted in 12 levels.

3

LCD Contrast Adjustment (CONTRAST)

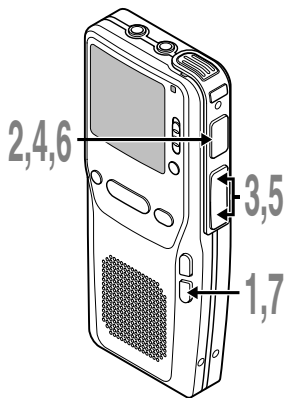

- 1 Press and hold the **FOLDER/MENU** button for 1 second or longer.

The menu appears (☞ P.41).

- 2 Press the **FF** or **REW** button to choose “SUB MENU”, and press the **REC** button.

The sub menu appears (☞ P.41).

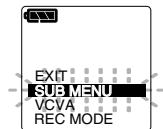

- 3 Press the **FF** or **REW** button until “CONTRAST” flashes on the display.

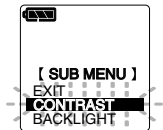

- 4 Press the **REC** button.

The LCD display contrast setup process begins.

- 5 Press the **FF** or **REW** button to set the contrast level.

You can adjust the LCD display contrast level from 1 to 12.
(Initial setting6)



- 6 Press the **REC** button to complete the setup screen.

- 7 Press the **FOLDER/MENU** button to close the menu.

Backlight (BACKLIGHT)

The recorder display backlight is ON by default. The display will lit for about 15 seconds when a button on the recorder is pressed. The backlight feature can be turned off from the menu.

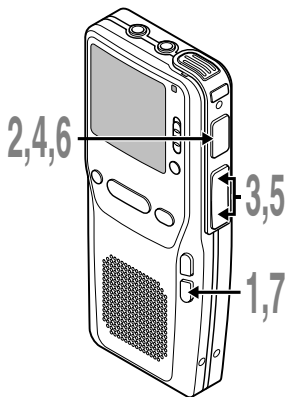

- 1 Press and hold the **FOLDER/MENU** button for 1 second or longer.

The menu appears (see P.41).

- 2 Press the **FF** or **REW** button to choose “SUB MENU”, and press the **REC** button.

The sub menu appears (see P.41).

- 3 Press the **FF** or **REW** button until “BACKLIGHT” flashes on the display.

- 4 Press the **REC** button.

The backlight setup process begins.

- 5 Press the **FF** or **REW** button to choose between “ON” and “OFF”.

ON: Backlight is enabled.

OFF: Backlight is disabled.

- 6 Press the **REC** button to complete the setup screen.

- 7 Press the **FOLDER/MENU** button to close the menu.

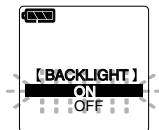
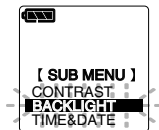
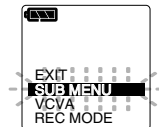

3 Backlight (BACKLIGHT)

System Sounds (BEEP)

The recorder beeps to alert you to button operations or warn you of errors. System sounds may be turned off.

3

System Sounds (BEEP)

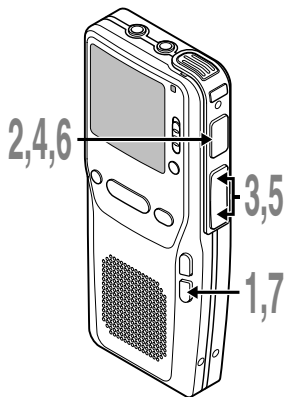

- 1 Press and hold the **FOLDER/MENU** button for 1 second or longer.

The menu appears (see P.41).

- 2 Press the **FF** or **REW** button to choose “SUB MENU”, and press the **REC** button.

The sub menu appears (see P.41).

- 3 Press the **FF** or **REW** button until “BEEP” flashes on the display.

- 4 Press the **REC** button.

The system sound setup process begins.

- 5 Press the **FF** or **REW** button to choose between “ON” and “OFF”.

ON: System sounds are enabled.
OFF: System sounds are disabled.

- 6 Press the **REC** button to complete the setup screen.

- 7 Press the **FOLDER/MENU** button to close the menu.

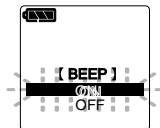
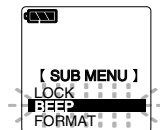
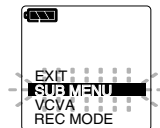

Menu Setting Method

Each item of the menu list can be set by the following method.

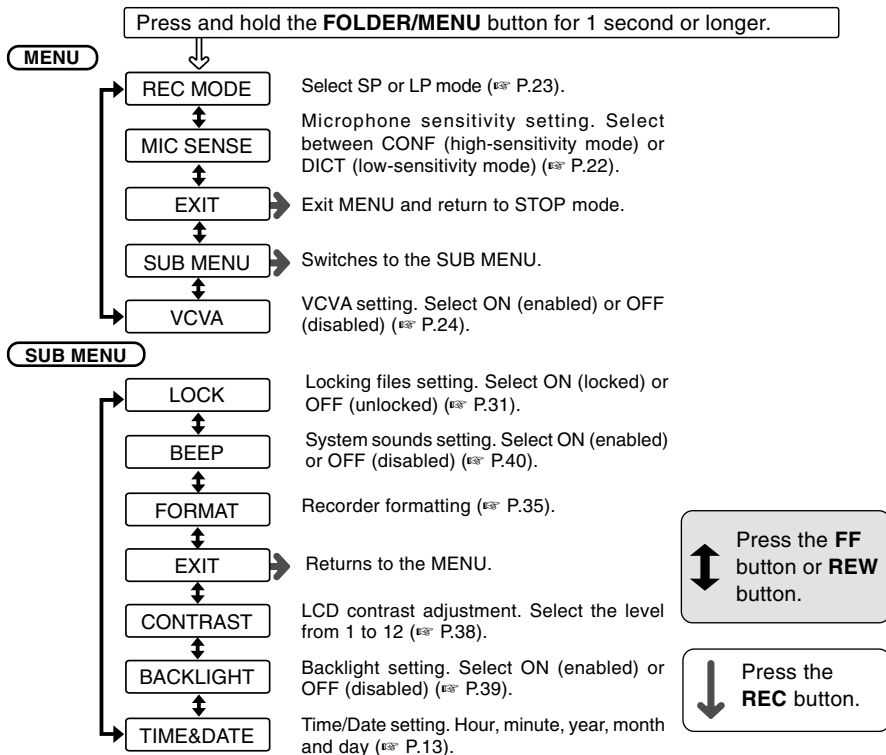

Notes

- If you press the STOP button or FOLDER/MENU button during a menu setup operation, the recorder will stop and apply the items that were set to that point.
- The recorder will stop if you leave it idle for 3 minutes during a menu setup operation, when a selected item is not applied.
- You can set the time and date on the recorder from your PC using DSS Player software (☞ P.42).

Using DSS Player Software

The DSS Player Software can be used to do the following:

- Playback voice files on your PC and on the recorder when connected via USB. Download files from the recorder to the PC or upload files from the PC to the recorder.
- If an upgrade (Option) to DSS Player Plus is executed, various additional functions can be utilized (P.65).

4

Precautions on using the recorder connected to a PC

- When you are downloading a file from the recorder or uploading a file to the recorder, do not remove the USB cable even if the screen is indicating you can. Data is still being transferred while the record/play indicator lamp is blinking. When removing the USB cable, be sure to follow the description in P.51. If the USB cable is removed before the drive is stopped, data may not be successfully transferred.
- On a PC, do not format the drive of the recorder. Initialization is not successfully achieved on a PC. For initialization, follow the instructions in the menu screen of the recorder (P.41).
- Folder (directory) names displayed by file management tools such as Explorer attached to Microsoft Windows and Finder attached to Mac OS are different from the folder names settable with the recorder or DSS player.
- If folders or files stored on the recorder are moved or renamed by using a file management tool such as Explorer or Finder, the order of files may be changed or files may become unrecognizable.
- Data can be written or uploaded to the recorder even though the attribute of the recorder drive is shown as Read-only by the operating system of the PC.
- As the noise may cause adverse effects on electronic devices nearby the recorder, unplug the earphone when you connect the recorder to a PC.

Operating Environment

Basic Operating Environment of DSS Player

Windows

PC:	IBM PC/AT compatible PC
Operating System:	Microsoft Windows Me/ 2000 Professional/XP Professional, Home Edition
CPU:	Intel Pentium II class 333 MHz processor or more (Processor 500 MHz or faster is recommended)
RAM:	128MB or more (256MB or more is recommended)
Hard drive space:	50MB or more
Drive:	2x or faster CD-ROM, CD-R, CD-RW, DVD-ROM drive
Sound card:	Creative Labs Sound Blaster 16 or 100% compatible sound card
Browser:	Microsoft Internet Explorer 4.01 SP2 or later
Display:	800 x 600 pixels or more, 256 colors or more
USB port:	One free port
Audio I/O terminals:	Earphone output or speakers
Others:	<ul style="list-style-type: none">• The mouse or similar to a pointing device.• Environment where the Internet can be utilized.

Macintosh

PC:	Power Mac G3 233 MHz class processor or faster iMac/ iBook/ eMac/ Power Mac/ PowerBook (The computer must support a standard USB port) (Processor 500 MHz or faster is recommended)
Operating System:	Mac OS 10.1/10.2/10.3
RAM:	128MB or more (256MB or more is recommended)
Hard drive space:	50 MB or more
Drive:	2x or faster CD-ROM, CD-R, CD-RW, DVD-ROM drive
Display:	800 x 600 pixels or more, 256 colors or more
USB port:	One free port
Audio I/O terminals:	Earphone output or speakers

Installing Software

Before you connect the recorder to your PC and use it, you must first install the DSS player software from the included Software CD.

Applications included with “DSS Player”

- DSS Player: Recorded voice files can be downloaded to the PC for complete file management and playback solution.
- Acrobat Reader is installed on your PC. It is required to view the accompanying manual in PDF format.

Be sure to confirm the following before installation:

- Exit all running applications.
- Eject the floppy disk if you are using one.
- If you are running Windows2000/XP or Mac OS X on the network, you need to log on as an Administrator.

4

Installing Software

Windows

1 Insert DSS Player into the CD-ROM drive.

The installation program will start automatically. Once the program starts, jump to step 4. If it does not, follow the procedures in steps 2 and 3.

2 Click the [start] button and select [Run].

3 Enter “D:\setup.exe” in the [Open] field and click [OK].

This is assuming the CD-ROM drive is D.

4 The installation Language Selection dialog box opens.

Click the desired language to select it.

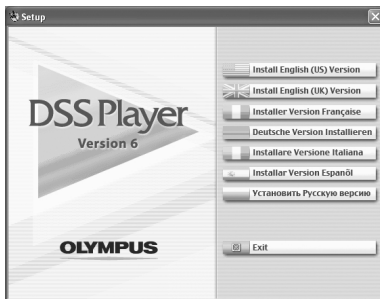

Installing DSS Player

5 Register user information.
Enter your name, company name and serial number. For the serial number, see the label attached to the CD-ROM package provided with DSS Player. When entered, click [Next]. When the confirmation dialog appears, click [Yes].

6 Confirm your acceptance of the terms of the Licensing Agreement.

You must accept the terms of the Licensing Agreement to install DSS Player. If you accept them, click [Yes].

7 Select where to install DSS Player.

This lets you specify the folder in which to install DSS Player. Click [Browse] to find the desired installation folder. To accept the default folder, click [Next].

Note

If the installation folder does not exist, a confirmation dialog box opens to get your permission to create a folder for this purpose. Click [Yes].

8 Select a program menu folder.
You may change the program menu folder to another one, such as [Start Up]. To accept the default folder, click [Next].

9 Authorizing the start of file copying.

Confirm all “Current Settings”. To accept them, click [Next].

Note

To change the program menu folder or installation folder, click [Back].

10 Copy files.
Wait until DSS Player is installed on your PC, then click [Finish]. The screen returns to the opening screen automatically.

Installing the Device Driver

11 Connect the recorder to your PC, referring to “Connection to Your PC” (P.50).

When you connect the recorder to your PC for the first time after installing DSS Player, the recorder’s driver will be installed automatically. If the driver is installed properly, DSS Player will start automatically.

(For details about operation for DSS Player see pages from P.52)

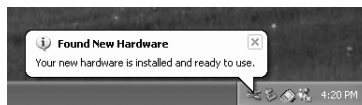

Macintosh

1 Insert DSS Player into the CD-ROM drive.

2 Double-click CD icon.

Double-click the desired language to select it.

3 Double-click the following icon.

4 Click [Continue] when the DSS Player opening screen appears.

5 Confirm your acceptance of the terms of the Licensing Agreement. You must accept the terms of the Licensing Agreement to install DSS Player. If you accept them, click [Agree].

6 Select where to install DSS Player. This lets you specify the folder in which to install DSS Player. To accept the default folder, click [Choose].
Installing DSS Player.

7 Completing setup.

Installation has finished. Click [Quit].

8 Register user information.

To use the DSS Player, it is necessary to register the user information at the time of initial startup.

Open the [DSS Player] folder created at installation, and the user's registration screen will be displayed, if the  is double clicked. Please input your name, company name, and serial number. Please see the seal attached to the CD-ROM package included with the DSS Player, for the serial number. After the input has ended, click [OK] to complete the registration.

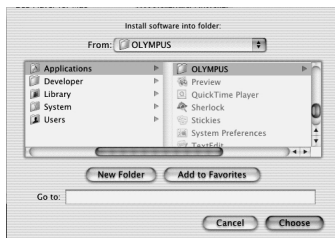

Uninstalling Software

To uninstall any of the software component of the DSS player software installed on your PC, follow the steps below.

Windows

- 1 Exit DSS Player.**
- 2 Select [Control Panel] from [start] menu.**
- 3 Click [Add/Remove programs] in the control panel window.**
- 4 A list of applications that have been installed is displayed.**
Select the software you would like to uninstall/remove.
- 5 Click [Change/Remove].**
- 6 Confirmation of Deleting the program.**
Click the [OK] button to start uninstalling.
An additional message may appear, if so, read it carefully and follow the instructions given.
- 7 When the [Maintenance Complete] screen is displayed, click [Finish] to complete uninstalling.**

Note

The voice files you made are stored in the [MESSAGE] folder. If you don't need them, delete them. You can confirm the location of the [MESSAGE] folder by clicking [Options] in the [Tools] menu before uninstalling.

Macintosh

1 Exit DSS Player.

2 Delete the Preferences File.

Delete the [DSS Preference] file in the following location.
Macintosh HD : Users : Library : Preferences

3 Delete the Executable File.

Delete the [DSS Player] file in the location where you installed the file.

4 Delete the Help File.

Delete the [DSS Player Help] file in the following location.
System Folder : Help

Note

The voice files you made are stored in the [MESSAGE] folder. If you don't need them, delete them. You can confirm the location of the [MESSAGE] folder by clicking on [Options] in the [Tools] menu before uninstalling.

Using Online Help

For information on the DSS Player usage and features, refer to the Online Help. To open Online Help, you have the following options.



Windows

- Click the [start] button, select [All Programs], then [Olympus DSS Player], then click [Help].
- While DSS Player is running, choose [Contents] from the [Help] menu.
- While DSS Player is running, press [F1] on the keyboard.

Macintosh

- While DSS Player is running, choose [DSS Player Help] from the [Help] menu.

Search by Contents

- 1 Once the Online Help screen appears, click the Contents tab.
- 2 Double-click the  icon of the desired topic heading. The title of the topic is displayed.
- 3 Double-click the  icon of the desired topic. An explanation of the topic is displayed.



Search by Key word

- 1 Once the Online Help screen appears, click the Index tab.
- 2 Enter text. Matching keywords are located automatically.
- 3 Choose a topic, then click [Display]. An explanation of the topic is displayed.

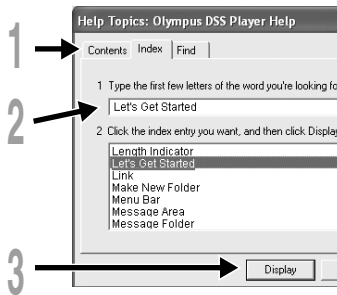

Note

You will be able to use Online Help after DSS Player is installed.

Connection to Your PC

Be sure to install the DSS Player software before connecting the recorder to a PC. You can directly connect the recorder's USB terminal to your PC.

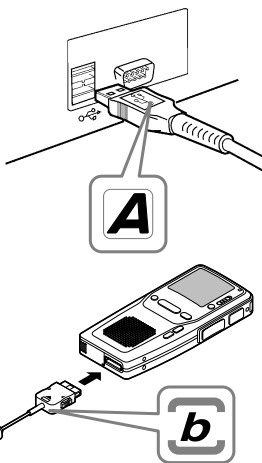

4

Connection to Your PC

Connecting to your PC Using the USB Cable

- 1 Turn ON the recorder (see P.12).
- 2 Insert end **A** of the USB cable to your PC's USB port or USB hub.
- 3 Make sure the recorder has stopped before attaching end **b** of the USB cable to the terminal port of the recorder.
If "REMOTE" is displayed on the recorder, it indicates proper connections.

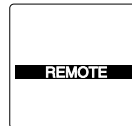

Once you connect the recorder to your PC, the recorder will be powered through the USB cable. The batteries will not be in use.

Windows

When the recorder is connected and "My Computer" is opened, a removable disk drive is displayed. If "Add New Hardware Wizard" appears, cancel the wizard by pressing the [Cancel] button and then install DSS Player.

Macintosh

If the recorder is connected to Mac OS, an icon with a drive name of "Untitled" appears.

Disconnecting from Your PC

Windows

1 Click the  on the task bar located at the lower-right corner of the screen. Click [Safely Remove Hardware].

It will read [Stop USB Disk-Drive] for Windows Me. The drive letter will differ depending on the PC being used.

2 Disconnect the USB cable.

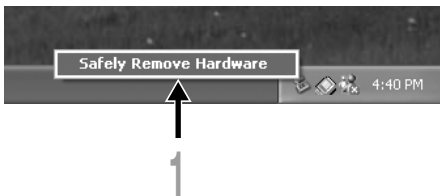

Macintosh

1 Move the icon of the recorder's drive displayed on desktop to trash box by drag and drop.

2 Disconnect the USB cable.

Notes

- NEVER remove the card or disconnect the USB cable while the record/play indicator lamp is flashing. If you do, the data on the card will get destroyed.
- When the recorder is connected to a PC, the power will be supplied from the USB cable.
- Refer to the user's manual for your PC regarding the USB port or USB hub on your PC.
- Be sure that you connect the USB cable either directly to the USB port on your PC or the self-power (AC adapter connection) USB hub.
- Be sure to push the cable connector all the way in. Otherwise, the recorder may not operate properly.

Running DSS Player

Windows

By connecting the recorder to your PC, you can automatically start the application.

Disabling automatic start

- 1 Right click on the  of the taskbar on the lower right of the screen, and select [Setting]. The application which enables setting will be displayed by dialog.
- 2 Click the of the [DSS Player Version 6]. The check mark on [DSS Player Version 6] disappears. For automatic start, select and click DSS Player to reinstate again.

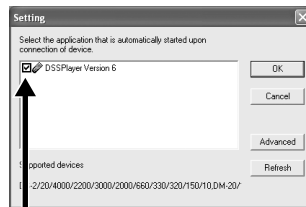

Manual start

- 1 Start Windows.
- 2 Click the [start] button, select [All Programs], then [Olympus DSS Player].
- 3 Click [Olympus DSS Player].

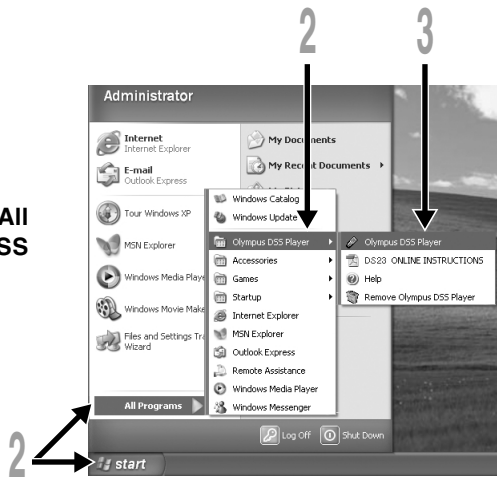

Note

52 You cannot run more than one DSS Player program or multiple copies of the same program simultaneously.

Macintosh

To start, open the “DSS Player” folder created upon installation and double-click the  icon. When it starts for the first time after installation, user information needs to be registered. Please see [P.46](#) for details.



Note

The Mac version DSS Player has no automatic start function.

Window Names

4

Window Names

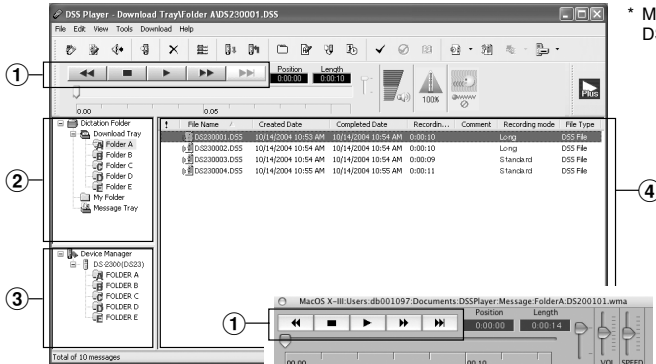

* Main screen displayed when DSS Player is started

Windows

Macintosh

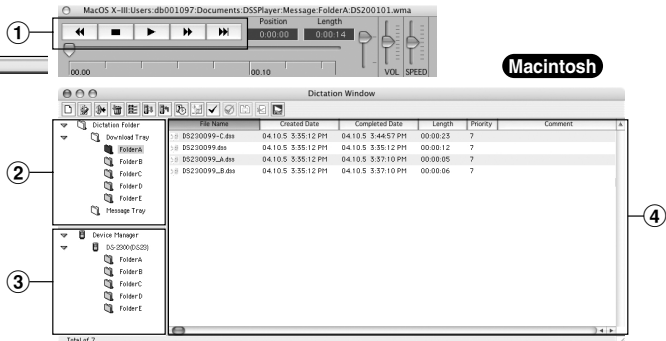

1 Play Control Bar

Control buttons to play and stop voice files.

2 Dictation Folder Window

Will display the directory structure of the DSS, WMA, WAVE (Windows only) and AIFF (Macintosh only)-format files stored on your PC's hard disk.

3 Device Manager Window

Will display the directory structure of the folders in the recorder.

4 Voice File List Box

Will display the voice files in the folder selected in 2 and 3.

Download Voice Files from the Recorder

There are 3 download options to transfer voice files from the recorder to the PC:

- Download Selected Files
Download one or several voice files to your PC.
- Download Folders
Download all the voice files in one folder.
- Download All
Click the  icon and download all the voice files stored in the recorder to your PC.

The following is an explanation of “Download Selected Files”. For explanations of “Download Folders” and “Download All”, refer to Online Help.

1 Select the folder.

From the Device Manager window, select the folder that contains the voice file you would like to download. The illustration shows that Folder A has been selected.

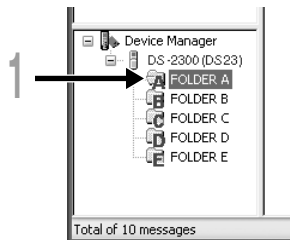

2 Select the voice file.

Select the voice file you would like to download from the Voice File List Box. To select more than one file, hold either the [Ctrl] or [Shift] key and select files. The illustration shows that one voice file is selected.

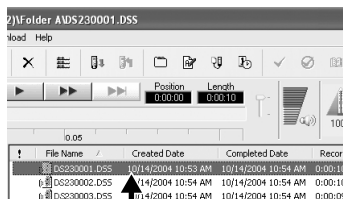

3 Download the voice file.

Windows

From the [Download] menu, click [Download Selected Files].

Macintosh

From the [Tools] menu, click [Download Selected Files].

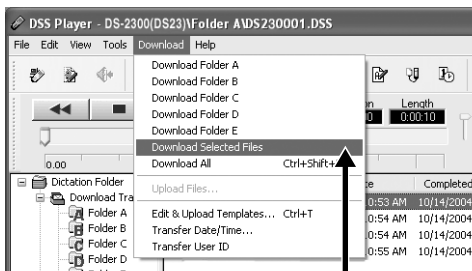

3

5

Download Voice Files from the Recorder

4 Download complete.

Do not disconnect the USB cable while the record/play indicator lamp on the recorder is flashing. Disconnecting the USB cable when the recorder lamp is flashing will result in data loss or corruption.

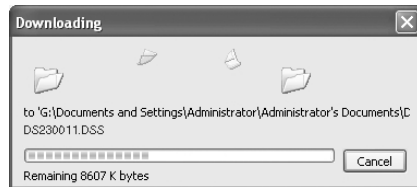

Notes

- NEVER remove the card or disconnect the USB cable while the record/play indicator lamp is flashing. If you do, the data on the card will get destroyed.
- Depending on the size of the voice file and your PC, it may take some time to download the files.
- The downloaded files will be stored in the download tray folder that corresponds to the folder in the recorder.
(Example: A voice file downloaded from Folder A will be stored in download tray A on your PC.)
- If a voice file already exists on your PC with the same name, date and time recorded, the new file will not be downloaded.

Play a Voice File

- 1 Select the folder.**
Select the folder that contains the voice file you would like to play.
- 2 Select the voice file.**
Select the voice file to play from the Voice File List Box.
- 3 Play the voice file.**
Click the  (play) button of the Play Control Bar.

Other playback control such as Rewind, Fast Forward, Stop, Speed Control, Volume Control, Time Axis and Index Skip are available from the Play Control Bar.

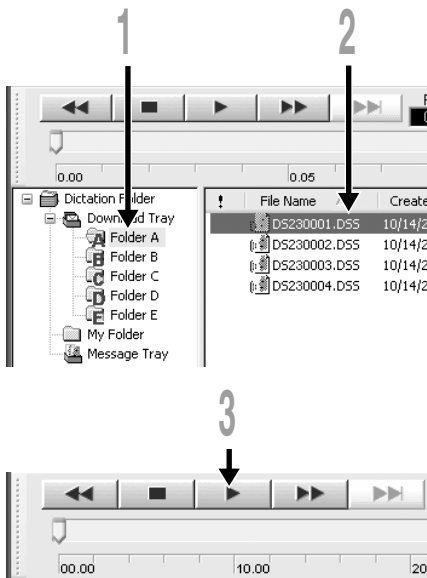

5

Play a Voice File

File Name Format

File names are assigned in the following manner:

DS23 0001 .DSS

Extension

File number A serial number automatically assigned by a Digital Voice Recorder.

User ID The name that has been set on the Digital Voice Recorder. The default name on the Digital Voice Recorder is "DS23". The user ID can be modified with DSS Player (® P.61).

Upload Voice Files to the Recorder

DSS Player has a feature to enable you to upload DSS-format voice files from your PC to the recorder.

1 Select the folder.

Select the folder that contains the voice file to upload from the Dictation Folder window.

2 Select the voice file.

Select the voice file to upload from the Voice File List Box.

3 Select the folder to upload.

Windows

From the [Download] menu select [Upload Files] or click the Upload icon. Once the folder list box where the file is to be uploaded is displayed, select the folder from which the file is to be uploaded.

Macintosh

From the [Tools] menu, click [Upload Files]. Once the folder list box where the file is to be uploaded is displayed, select the folder from which the file is to be uploaded.

4 Upload the voice file.

The voice file is uploaded to the recorder.

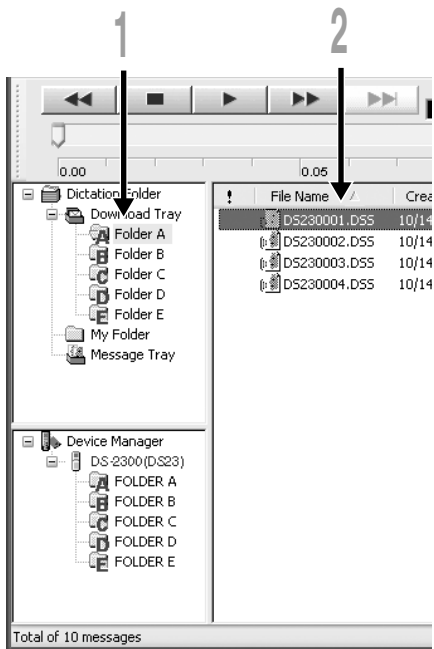

5

Upload Voice Files to the Recorder

5 Upload complete.

Once the transmission screen closes and the record/play indicator lamp on the recorder is OFF, upload is completed.

You can also drag and drop files from the Voice File List Box to the Device Manager window.

Notes

- NEVER remove the card or disconnect the USB cable while the record/play indicator lamp is flashing. If you do, the data on the card will get destroyed.
- If a file with the same name exists in the folder of this recorder, it cannot be transferred.

Direct Recording/Editing on PC

You can easily record on the PC directly using the recorder and the DSS Player. While the recorder is connected to the PC with the USB cable, the Remote Dictation window in the DSS Player allows you to create a new recording or edit an existing recording. The recorder will act as a sophisticated microphone with the buttons controlling the recording or editing process. See the Online Help for details (see P.49.)

Windows



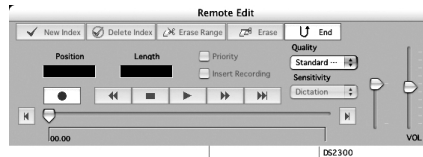

Macintosh



5

Direct Recording/Editing on PC

Recording a new file

- 1 From the DSS Player main window, click the [File] menu, then select [New File], or click the  icon. Remote Dictation window appears.
- 2 Press the  (record) button in the Remote Dictation window or press the REC button on the recorder to start recording.
- 3 Press the  (stop) button or press the STOP button on the recorder to stop recording.

Editing existing files

- 1 From the DSS Player main window, select the file you want to edit from the Voice File List Box.
- 2 Click the [File] menu, then select [Edit File], or click the  icon. Remote Dictation window appears.
- 3 Edit the recording using the recorder buttons.
You can use the mouse connected to your PC and the Record and Playback controls to edit recordings.

Notes

- If you open the Remote Dictation window while the recorder is connected, the function of the recorder is changed to Audio device from Storage device automatically. The recorder as AUDIO device is not displayed as a removable drive on your PC. Closing the Remote Dictation window and returning to the main screen will switch the recorder back to storage class device displayed as a removable drive.
- You cannot edit WAV files.
- The maximum recording time per file is 99 hours.

Send Voice Files with E-mail

Audio files are stored in the Message folder on the hard disk. If you want to send a voice file by attaching it to E-mail, select the file from the Message folder.

The Message folder location can be found from the [Tools] menu, [Options], and then “Download folder” tab.

The file can be replayed with DSS Player-Lite even though the recipient does not have DSS Player. Free DSS Player-Lite can be downloaded from Olympus homepage.

http://www.olympusamerica.com/cpg_section/cpg_downloads.asp
http://olympus-europa.com/consumer/2590_software.cfm

Changing User ID

The user ID is used in file names that are recorded on a Digital Voice Recorder.

1 Enter the user ID in the [Transfer User ID] window.

Windows From the [Download] menu.

Macintosh From the [Tools] menu.

2 Click [Transfer].

The new user ID will be transferred to the Digital Voice Recorder.

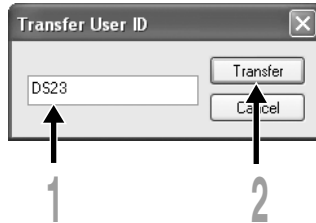

Note

NEVER remove the card or disconnect the USB cable while the record/play indicator lamp is flashing. If you do, the data on the card will get destroyed.

Changing a Folder Name

Changing a folder name in the Voice Folder window

Windows

You can change a folder name using the [Rename Folder] command from the [Edit] menu. A folder name can be up to 20 characters long and cannot use \/:*?"<>|.

Macintosh

Choose the [Rename Folder] command from the [File] menu.

Changing a folder name in the Device window

Windows

Right-click the folder name to change, select the [Rename Folder] and input the new folder name.

Macintosh

Choose the [Rename Folder] from the [File] menu and type a folder name. The names of the folders on the Digital Voice Recorder is updated with the new folder names. Device Window folder names consist of a string of 12 or fewer single-byte alphanumeric characters.

Note

NEVER remove the card or disconnect the USB cable while the record/play indicator lamp is flashing. If you do, the data on the card will get destroyed.

Editing File Comments

You can use a PC to create or edit file comments in DSS Player in the [Edit Comments] window, and transfer them from the PC to the recorder. You can also edit file comments imported from the recorder to a PC.

Choose the [Edit Comments] command from the [Tools] menu. Files comments can use up to 100 alphanumeric characters and symbols.

Note

NEVER remove the card or disconnect the USB cable while the record/play indicator lamp is flashing. If you do, the data on the card will get destroyed.

USB Microphone/USB Speaker

The recorder can be used as a USB speaker or microphone when connected to a PC. If you use the recorder as a USB speaker, you can output voice through the recorder instead of using the PC speaker. When used as a microphone, you can record voice on your PC using your favorite application.

Windows

1 Click the  icon in the toolbar to change the recorder to Audio device.

Macintosh

1 From the [Tools] menu, select [Change to audio device].

Uses as a USB Speaker

If this recorder is connected by USB, it can function as a USB speaker. If the recorder is used as a USB speaker, audio output can be done through the recorder, without audio output from the speaker attached to the computer.

Select the [Select Audio Output] from the [Tools] in the menu bar, and change the output destination.

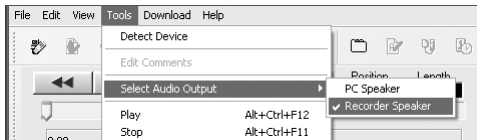

Uses as a USB microphone

If this recorder is connected by USB, it can function as a USB microphone. Also, if an upgrade (P.65) is executed to the DSS Player Plus, voice recognition software or other applications using this recorder as a microphone, voice can be input to a computer.

Windows 2000, Me

Select [Control Panel] → [(Sound and) Multimedia] → [Audio] tab, and select the [USB Audio Device] from the recording device.

Windows XP

Select [Control Panel] → [Sound and Audio Device] → [Audio] tab, and select the [Microphone Control (DVR)] from the recording device.

.....

Notes

- If you switch the recorder to Audio device, the recorder does not function as Storage device, and it is not displayed as a removable drive.
- Changing the USB speaker can be executed from the [Control Panel] as well as the USB microphone.

The “DSS Player” enables upgrades (Options) to the “DSS Player Plus” which is equipped with more functions. In addition to the DSS Player functions, voice recognition using voice recognition software, joining of files, sharing of files and the menu setting of this recorder can be utilized.

Purchase and Upgrade

To purchase “DSS Player Plus” and upgrading from “DSS Player” is operated in the following procedures.

Windows

Macintosh

1 Start the DSS Player.

Please see  P.52 for the starting method.

2 Click the button or select [Purchase a new license for DSS Player Plus] in the [Help] menu.

The web browser will start and the purchase site of the DSS Player Plus will be displayed. Please operate according to guidance on the screen.

When the purchase procedure is completed, the license number will be issued by mail.

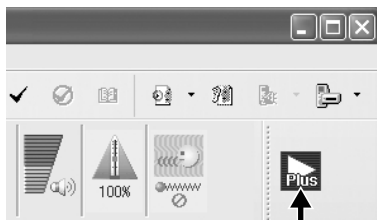

3 Select [Upgrade to DSS Player Plus] from the [Help] menu.

The “Upgrade to DSS Player Plus” dialog will be displayed.

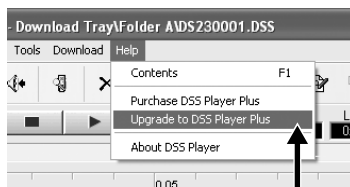

4 In the [Upgrade to DSS Player Plus] dialog, enter the license number of your purchase, and click the [OK] button.

When starting the application next time, DSS Player will be upgraded to DSS Player Plus.



Upgrading to DSS Player Plus

When upgraded, the title of the main menu changes to [DSS Player Plus]. Also, you can confirm the upgrade by selecting [About DSS Player] from the [Help] menu on the tool bar. In the [About DSS Player] window, the [DSS Player Plus] should be displayed.

Notes

- To purchase the license number, it requires an environment where the Internet can be utilized.
- Please see the details in the website regarding the purchase of the license number.

In conjunction with “ViaVoice” of IBM Corp. or “Dragon NaturallySpeaking” of ScanSoft Inc. which are on the market, the files recorded in this recorder can be transferred to a computer and converted to text. Please see the instruction manual for the voice recognition software for details.

The voice recognition software which is confirmed for use with this recorder is as follows. (As of February, 2005)

IBM Corp.

- IBM ViaVoice Pro USB Edition 10

ScanSoft, Inc.

- Dragon NaturallySpeaking 8

Please inquire to the Olympus Service Center regarding the situation for software to be released hereafter (P.85).

Also, when you use such software in combination with this recorder, please confirm the software operation with the user's computer and the maker.

- Please contact IBM for support information on the voice recognition software, ViaVoice.
- Please contact ScanSoft for support information on ScanSoft Dragon NaturallySpeaking.

Note

Voice recognition can only be used with Windows.

Voice Recognition in ViaVoice (Audio set up)

When the DSS Player Plus and IBM's voice recognition software "ViaVoice" are used together, execute the setting in the following procedure to record the voice accurately, acquired from the built-in microphone or speaker.

- 1 **Connect the recorder to your PC, and start the DSS Player Plus.**
- 2 **Click the [start] button, select [All Programs], then select [IBM ViaVoice VoiceCenter].**
- 3 **From the IBM [ViaVoice VoiceCenter], select [ViaVoice], [Tools], then [Analyze My Voice].** The ViaVoice User Wizard window appears.
- 4 **From the [Device] list box, select [Olympus DSS File] or [Olympus WMA File].**
Select [Olympus DSS File] or [Olympus WMA File] in the [Device] list box, then click the [Next] button.
- 5 **Click the [Next] button.** The [Audio Setup Wizard] window appears.

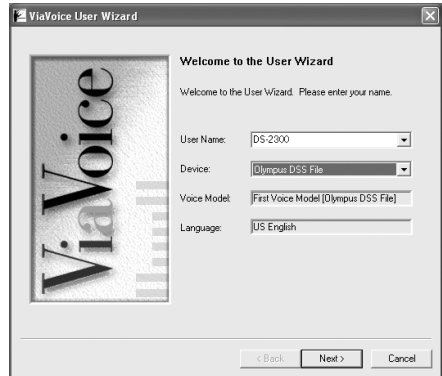

5

6 Select a sound card. When the [Selecting a Sound Card] window appears, select [USB Audio Device] for [Input] and follow the instructions on screen. (Select [Microphone Control (DVR)] for Windows XP.)

7 Proceed with the AUDIO Setup according to the instruction on screen. During audio setup, enrollment, please input voice data from the recorder.

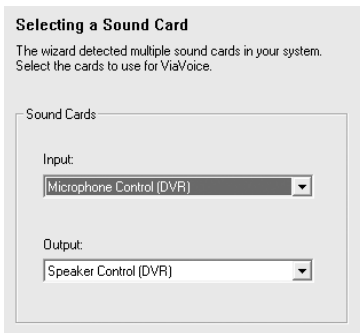

It is recommended that you enroll while in your normal surrounding environment settings. This will help improve the voice recognition by registering your voice characteristics and your environment.

Voice Recognition in Dragon NaturallySpeaking (Training)

When the DSS Player Plus and ScanSoft's "Dragon NaturallySpeaking 8" are used together, create the user in "Dragon NaturallySpeaking 8" in advance. It is necessary to execute the training. By executing it, the features of your voice will be registered, and the rate of recognition will improve. Please advance the setting according to the following procedures.

1 Startup Dragon NaturallySpeaking 8.

Click the [start] button, select in the order of [All Programs] → [Dragon NaturallySpeaking 8] → [Dragon NaturallySpeaking 8].

* If the DSS Player Plus has started, please close it in advance.

2 [New User Wizard] will be displayed.

* If the user is already registered in Dragon NaturallySpeaking 8, the [Open User] dialog will be displayed. In this case, click the [New] button and display [New User Wizard].

3 Creating a User.

Input a name into [Your name], and select [Olympus IC Recorder DS-2300] from the [Dictation source] list box, then click the [Next] button.

4 Description of Wizard.

Description of this wizard will be displayed. Click the [Next] button.

New User Wizard

Create User

Your name: DS-2300

Language: US English

Dictation source: Olympus IC Recorder DS-2300

Vocabulary: General Advanced...

To continue, click Next.

< Back Next > Cancel Help

5 Recording Training Text.

Follow the instructions on the screen, and record the training text to this recorder. At this time, record with “SP” for the recording mode, and “DICT” for the microphone sensitivity. Please refer to “Notes on Recording For Voice Recognition” (P.74) for recording tips. After the recording is finished, click the [Next] button.

6 Transferring the Recorded Voice.

Click [Olympus DSS Player] button displayed on the screen. The DSS Player Plus will startup and then follow the instructions displayed on the screen to execute the transfer of the recorded voice. After finishing, click the [Next] button.

7 Adding a User.

Click the  button displayed on the screen. After this operation is finished, follow the instructions on the screen, then complete the registration for a new user.



Executing Voice Recognition

DSS Player Plus can easily access ViaVoice and Dragon NaturallySpeaking 8 from the menu, and it enables text conversion of the file in the Voice File List Box.

1 Select the folder.

From the Dictation Folder Window, select the folder in which the file to be converted to text is stored.

2 Select the voice file.

From the Voice File List Box, select the file to be converted to text.

3 Start of voice recognition.

Clicking the arrow at the right side of the voice recognition icon  displays the voice recognition software. Select and click ViaVoice or Dragon NaturallySpeaking as the software to be used.

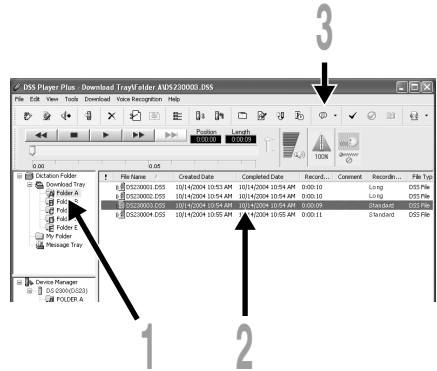

When Dragon NaturallySpeaking is Selected

The [Open User] dialog will be displayed, and select the user created in procedure 3 on P.70, then click the [Open] button. The [Transcription Options] dialog will be displayed, and select the option according to the purpose, then click the [Transcribe] button.

The text conversion will start. However, if the voice recognition software start icon  becomes an invalid display.

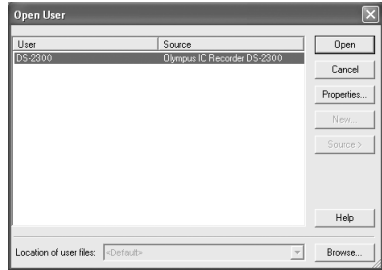

Noise Canceling Function

Check [Use Noise Cancellation] in the [Voice Recognition] menu to output voice using the noise canceling function to the voice recognition software.

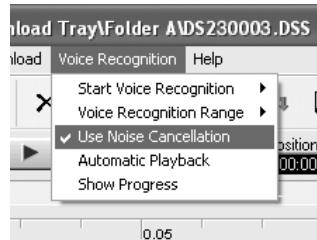

Note

The voice recognition of the file recorded in LP mode cannot be recognized.

Notes on Recording For Voice Recognition

When recording voice to be processed with voice recognition, set up your DSS recorder as follows to improve recognition accuracy.

- Set the microphone sensitivity to “DICT” (☞ P.22).
- Set the recording mode to “SP” (☞ P.23).
- Set the Variable Control Voice Actuator (VCVA) to “OFF” (☞ P.24).
- Register/enroll your voice in the voice recognition software using the recorder.
- Record in a relatively quiet environment.
- Have the recorder microphone 5 to 10 cm (2 to 4 inches) away from your chin.

- Speak normally.
- It is recommended to use the noise-cancellation microphone ME12, when recording.

The file recorded in the next condition, will be a low rate of recognition, which can not be used for voice recognition.

- A conference or meeting where many voices are recorded.
- Seminar or lecture where high-level ambient noise tends to be recorded.

Joining Files

In DSS Player Plus, designated multiple voice files can be joined and one voice file can be created.

1 Select the folder.

From the Dictation Folder Window, select the folder which contains the files to be joined.

2 Select the voice files.

From the Voice File List Box, select more than one file to be joined.

3 Select [Join] from the [Edit] menu or press the button.

The dialog to join files will be displayed, listing the files selected in step 2.

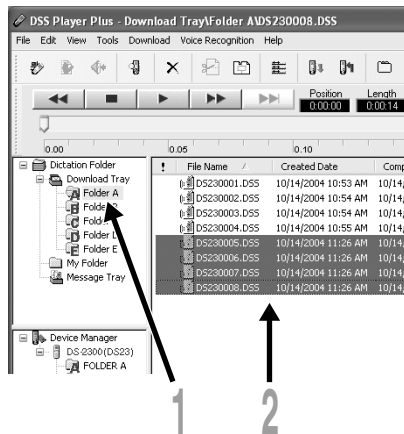

5

Joining Files

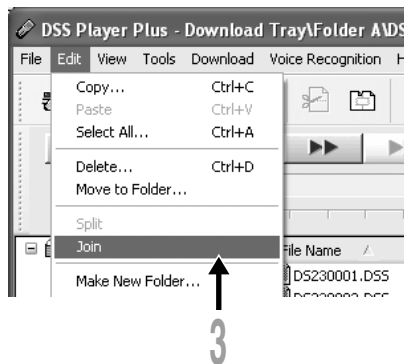

4 Set the order of files.

After joined, the playback order of the files can be changed. Select a file, and move the file to its appropriate position in the order using the [Up] and [Down] buttons.

5 Input File Names.

The file name is created automatically after joining and also, it enables input optionally.

6 Press the [Join] button.

The resulting file is saved under the name specified in step 5, and stored in the selected folder.

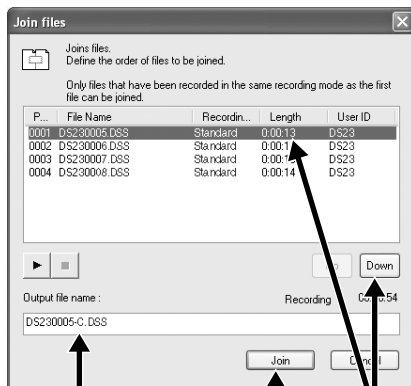

Note

If the files to be joined have different recording modes, the mode of the file listed at the top is selected.

One designated voice file can be split into the two files in DSS Player Plus.

- 1 **Select the folder.**
Select the folder containing the file to be split from the Dictation Folder Window.
- 2 **Select the voice files.**
Select one file to split from the Voice File List Box.
- 3 **Select [Split] from the [Edit] menu or press the  button.**
The setting dialog of the file to be split will be displayed.

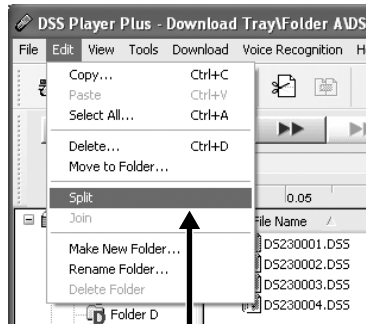
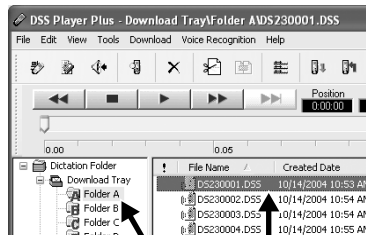

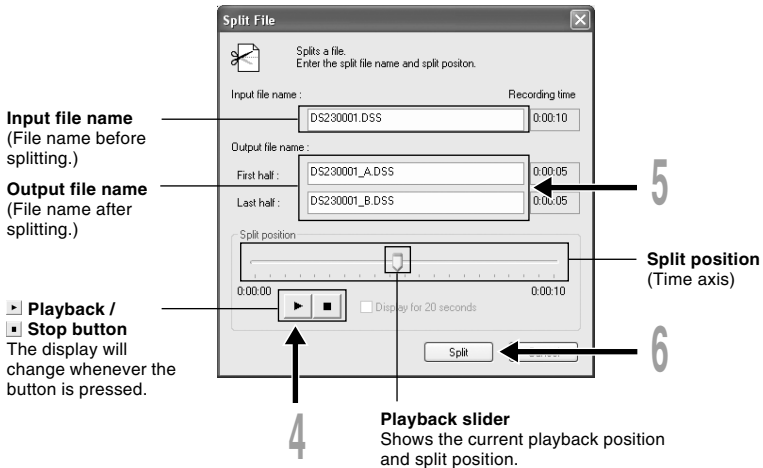

4 Set the split position.

Press the button to playback the file, and press the button in the position to be divided.

Also, the playback slider position in the time axis shows the current playback position, and also shows the split position (slide the playback slider to the right or left, which enables moving to the position to be split).

5 Input File Names.

The file name is created automatically after splitting and also, it enables input optionally.

6 Press the [Split] button.

The splitting of the file will complete, and the file name designated in procedure 5 will be saved.

Menu Setting of this Recorder

The menu setting of this recorder can be changed in the “Configure recorder menu” screen in the computer.

1 Select [Configure recorder menu] from the [Download] menu.

The “Configure recorder menu” dialog will be displayed.

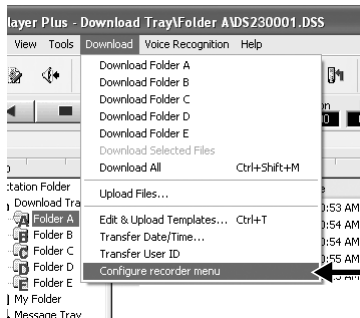

2 Execute Menu Setting.

Click the radio button to be changed, and input a check.

3 Press the [OK] button.

The set contents will be transferred to this recorder. After the finishing, the menu setting of this recorder will be changed by removing the USB connection of this recorder from the computer.

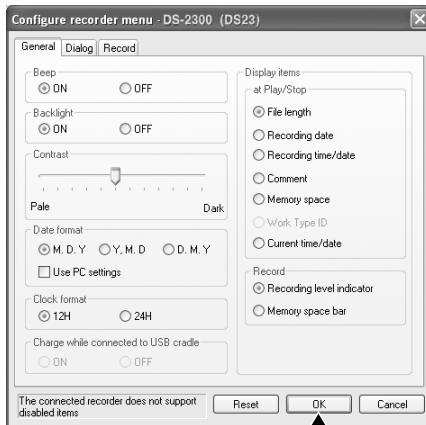

Using the Recorder as a Reader/Writer

When the recorder is connected to your PC, it will be recognized on your PC as a removable drive. You can view and access the recorder card from My Computer and download data from the card to your PC using standard windows copy/move and delete commands. You can also upload data from the PC to the card in the recorder in the same way.

Example: Copying Data from PC to Card Using Explorer or Finder

- 1 Start Windows.**
- 2 Connecting the recorder to your PC.**
For connection procedure, refer to “Connecting to Your PC Using the USB Cable” (P.50).
- 3 Open Windows Explorer or Finder window.**
The recorder will appear as a removable drive icon.
- 4 Copy data to card.**
While the data are being written or copied, the record/play indicator lamp on the recorder will flash.

Note

NEVER remove the card or disconnect the USB cable while the record/play indicator lamp is flashing. If you do, the data on the card will get destroyed.

Alarm Message List

Message	Meaning	Explanation	Action
BATTERY LOW	Low battery power	Battery power is getting low.	Replace with new batteries (☞ P.11).
FILE IS LOCKED	Erase-locked	Tried to delete a locked file.	Unlock the file (☞ P.31).
INDEX FULL	Index full	The file is full of index marks (maximum of 16 marks).	Erase index marks that are no longer required (☞ P.32).
FOLDER FULL	Folder full	The folder is full of files (maximum of 199 files).	Erase unnecessary files (☞ P.29).
	Maximum number	The destination folder already has the maximum number of files (199).	Erase unnecessary files (☞ P.29).
MEMORY ERROR	Incompatible card	An incompatible card was inserted.	Insert a compatible card.
MEMORY FULL	Zero remaining memory	The card has no remaining memory.	Erase files that are no longer required or insert another card.
FORMAT ERROR	Formatting error	There was an error while formatting the card.	Reformat the card (☞ P.35).
INSERT CARD	No card	There is no card inserted.	Insert a card (☞ P.16).
CARD COVER IS OPEN	Card cover is opened	The card cover is not closed.	Close the card cover securely until it click (☞ P.16).
SYSTEM ERROR	System error	System error detected in the recorder.	This is a malfunction. Contact the place of purchase or Olympus Service Center for repair.

Troubleshooting

Symptom	Probable cause	Action
Nothing appears on the display	The batteries are not loaded properly.	Verify polarity is correct (☞ P.11).
	The batteries are dead.	Replace with new batteries (☞ P.11).
	The recorder is in power off mode.	Turn the recorder ON (☞ P.12).
Won't start	The recorder is in power off mode.	Turn the recorder ON (☞ P.12).
	The batteries are dead.	Replace with new batteries (☞ P.11).
Unable to record	The card does not have enough memory.	Erase unnecessary files or insert another card (☞ P.16, 29).
	The card is unformatted.	Format the card (☞ P.35).
	The maximum number of files has been reached.	Check another folder.
No playback tone heard	The earphone is connected.	Unplug the earphones to use the internal speaker.
	The VOLUME button is set to 0.	Adjust the VOLUME button.
Unable to erase	The file is locked.	Unlock the file (☞ P.31).
Noise heard during playback	The recorder was shaken during recording.	—
	The recorder was placed near a cell phone or fluorescent lamp while recording or during playback.	Move the recorder.
Recording level too low	The microphone sensitivity is too low.	Set the microphone sensitivity to CONF mode and try again (☞ P.22).
Unable to set index marks	The maximum number of index marks (16) has been reached.	Erase unnecessary index marks (☞ P.29).
	The file is locked.	Unlock the file (☞ P.31).
Cannot find the recorded voice	Wrong folder.	Switch to the right folder.
Cannot connect to PC	Sometimes a connection cannot be made with some PCs running Windows XP.	You need to change the PC's USB settings. See DSS Player online help for details (☞ P.49).

Accessories (optional)

PC Transcription kit : AS-2300

The AS-2300 transcription kit provides you with a PC-footswitch, a headset and DSS Player software for easy transcription of DSS recordings.

xD-Picture Cards of 16, 32, 64, 128, 256 and 512 MB: M-XD16/32/64/128/256/512

Olympus CAMEDIA digital camera series xD-Picture Cards can be used.

Headset: E102

Stereo headset for your PC. A helpful tool for PC based transcription.

Monaural binaural earphone: E20

Noise-Cancellation monaural microphone: ME12

(Dictation microphone)

Used to get crisp recordings of your own voice by reducing the effects of ambient noise. This is useful microphone and suits for voice recognition.

External microphone: ME15

A lavalier omnidirectional microphone that clips to clothing. Used to record your own voice or people near you.

Ni-MH Rechargeable Battery Charger: BU-400 (Europe only)

Charger for AA batteries (1 to 4) or 1 to 2 AAA batteries.

Ni-MH Rechargeable Battery: BR401

High-efficiency rechargeable long life batteries.

Connecting cord: KA333

Use to connect the microphone jack of this unit to a radio or other sound source.

Plug adapter: PA3

A mini plug adapter to connect 2.5 mm mini-plug devices such as microphone to the recorder 3.5 mm mini-jack.

USB Reader/Writer: MAUSB-10 (Dual-Slot xD-Picture Card & SmartMedia)

Allows data to be transferred to and from a PC.

USB Reader/Writer: MAUSB-300 (xD-Picture Card)

Allows data to be transferred to and from a PC.

PC Card adapter: MAPC-10 (xD-Picture Card/SmartMedia)

Allows data to be transferred to and from a PC that has a PC card slot.

Specifications

Recording format

DSS (Digital Speech Standard)

Input level

-70 dBv

Sampling frequency

SP mode: 12 kHz

LP mode: 8 kHz

Overall frequency response

SP mode: 300 to 5,000 Hz

LP mode: 300 to 3,000 Hz

Recording time (16MB Card)

SP mode: 2 hours 30 minutes

LP mode: 5 hours 30 minutes

Alkaline battery life

Recording:

Approx. 20 hours

Playback:

Approx. 12 hours

Ni-MH Rechargeable Battery (BR-401) life

Recording:

Approx. 15 hours

Playback:

Approx. 10 hours

Speaker

Built-in \varnothing 28 mm round dynamic speaker

MIC jack

\varnothing 3.5 mm mini-jack, impedance 2k Ω or more

EAR jack

\varnothing 3.5 mm mini-jack, impedance 8 Ω or more

Maximum working output (3 V DC)

220 mW or more (8 Ω speaker)

Input power requirement

Rated voltage: 3 V

Batteries: Two AAA batteries (LR03 or R03) or

Two Ni-MH rechargeable batteries (BR-401)

External dimensions

110.2 x 50.0 x 17.2 mm
(without protrusions)

Weight

101 g (including alkaline batteries)

* Specifications and design are subject to change without notice.

* Battery life is measured by Olympus. It varies greatly according to the type of batteries used and the conditions of use.

Technical Assistance and Support

The following are contact information for technical support for Olympus recorders and software only.

- ◆ Technical Hotline Number in the U.S. and Canada
1-888-553-4448
- ◆ User Support E-mail address in the U.S. and Canada
distec@olympus.com
- ◆ Technical Hotline Number in Europe
Toll free number
00800 67 10 83 00
available for Austria, Belgium, Denmark, Finland, France, Germany, Italy, Luxemburg,
Netherlands, Norway, Portugal, Spain, Sweden, Switzerland, United Kingdom
- Charged numbers for the Rest of Europe
+49 180 567 1083
+49 40 23773 899
- ◆ User Support E-mail address in Europe
dss.support@olympus-europa.com

OLYMPUS®

OLYMPUS IMAGING CORP.

Shinjuku Monolith, 3-1 Nishi-Shinjuku 2-chome, Shinjuku-ku, Tokyo 163-0914, Japan. Tel. 03-3340-2111

OLYMPUS IMAGING AMERICA INC.

Two Corporate Center Drive, PO BOX 9058 Melville, NY 11747-9058, U.S.A. Tel. 1-800-622-6372

OLYMPUS IMAGING EUROPA GMBH

(Premises/Goods delivery) Wendenstrasse 14-18, 20097 Hamburg, Germany. Tel. 040-237730

(Letters) Postfach 10 49 08. 20034 Hamburg. Germany.

OLYMPUS UK LTD.

2-8 Honduras Street, London EC1Y 0TX, United Kingdom, Tel. 020-7253-2772

<http://www.olympus.com>

For customers in North and South America

Declaration of Conformity

Model Number: DS-2300
Trade Name: DIGITAL VOICE RECORDER
Responsible Party: OLYMPUS IMAGING AMERICA INC.
Address: 2 Corporate Center Drive, PO BOX 9058 Melville, NY 11747-9058, U.S.A.
Telephone Number: 800-622-6372

This device Complies with Part 15 of the FCC Rules. Operation is subject to the following two conditions:
(1) This device may not cause harmful interference, and (2) this device must accept any interference received, including interference that may cause undesired operation.



Tested To Comply
With FCC Standards

FOR HOME OR OFFICE USE

Canadian RFI

This digital apparatus does not exceed the Class B limits for radio noise emissions from digital apparatus as set out in the Radio Interference Regulations of the Canadian Department of Communications.

Cet appareil numérique ne dépasse pas les limites de Catégorie B pour les émissions de bruit radio émanant d'appareils numériques, tel que prévu dans les Règlements sur l'Interférence Radio du Département Canadien des Communications.

For customers in Europe



"CE" mark indicates that this product complies with the European requirements for safety, health, environment and customer protection.



This symbol [crossed-out wheeled bin WEEE Annex IV] indicates separate collection of waste electrical and electronic equipment in the EU countries.

Please do not throw the equipment into the domestic refuse.

Please use the return and collection systems available in your country for the disposal of this product.

P2-BZ8090-01
AP0503